

MIKROFILL

Mikrofill 80 | 100080

The Mikrofill 80 is an extremely compact and convenient sealed system pressurisation package. Comprising the Mikrofill 3 advanced 'direct-type' pressurisation unit capable of cold fill pressurising a system up to 4.7 bar, a MikroPro 80 litre (6 bar) expansion vessel and a 1" quick fit service valve, the Mikrofill 80 is suitable for a range of LPHW/CHW applications.



Mikrofill 3 Features

- Fills any LPHW/CHW system from empty
- Connects directly to the mains/boosted water supply
- 4.7 bar cold fill pressure
- Consumes 10 watts on standby and 30 watts fully operational per hour
- Compact size & wall mounted
- Digital control system and LCD graphic display
- Automatic system fill and top-up
- Easy to install and set up
- High flow, WRAS approved fill valve
- Fill volume indicator – Aids water treatment calculation
- Category 4 backflow protection
- 2 year warranty

MikroPro Features

- 80 litre tank capacity
- For heating and chilled water applications
- Complies with the pressure equipment directive (PED) 97/23/EC
- Maximum operating temperature of 70°C
- Maximum operating pressures of 6 bar
- Durable powder coated finish
- Threaded connections

Applications

- Maintaining system pressure in large domestic and commercial sealed heating systems
- Maintaining system pressure in chilled water systems, refrigeration units and industrial cooling systems

Pressurisation Unit		Mikrofill 3 MIK120023
General	Warranty	2 years
	WRAS approval	Approved product (1806078)
	Conformity certification	UKCA / CE
	Mounting	Wall mount
	Intelligent control interface	✓
	System fill mode	✓
	Dry run protection	✓
Materials	Break tank	Polyethylene
	Front cover	Acrylic capped ABS
Performance	Maximum cold fill pressure	4.7 bar (470 kPa)
	flow rate (nominal)	14 l/min (at 2 bar)
	Maximum inlet pressure	5 bar (500 kPa)
	Ambient air temperature	Min 4 °C / Max 40 °C
	Relative humidity	95 % non-condensing
	Min./Max. water temperature	Min 4 °C / Max 23 °C
	Fluid category	CAT 4
Connections	Cold water inlet and outlet	15 mm compression x 300 mm flexible hose
	Drain (via tundish)	¾ BSP
Electrical	Power supply (Vac/Ph/Hz)	230 V a.c. / 1 / 50 Hz
	Power consumption (standby)	10 Watts
	Power consumption (standby)	30 Watts
	Current – full load	1 Amp
	Fuse rating	3 Amps
	Maximum load BMS relays	5 Amps
Physical	Enclosure protection	IPX4
	Width	250 mm
	Depth	112 mm
	Height	270 mm
	Weight – including fittings	5 Kg

Expansion vessel		MikroPro 8 EVZ290080
General	Warranty	2 years
	Conformity certification	UKCA / CE
	Mounting	Floor standing
Materials	Coating	Powder epoxy
	Connections	Carbon steel
	Diaphragm	Synthetic rubber compound
	Shell	Carbon steel
Performance	Maximum working pressure	6 bar
	Usable water capacity	80 litres
	Maximum operating temperature	70°C
Connections	Vessel inlet	1" M
Physical	Diameter	512 mm
	Height	558 mm
	Weight	13 kg

Mikrofill 3 Unit Dimensions

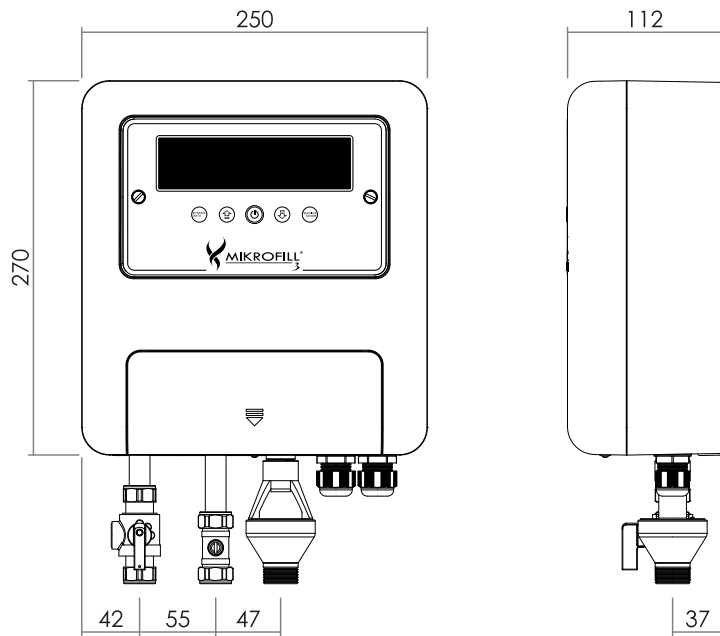

MikroPro 80 Dimensions

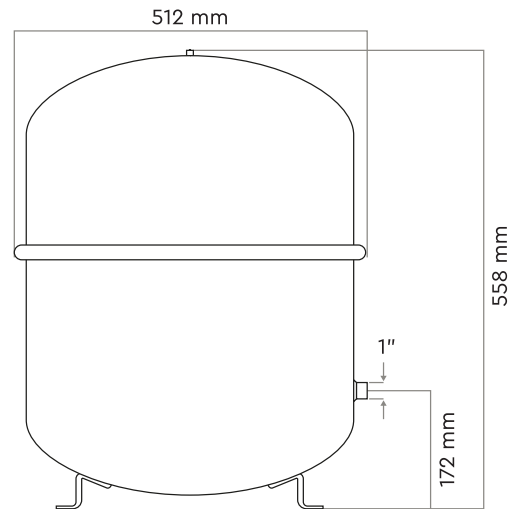

Stuart Turner Limited reserves the right to amend specifications without notice.

Stuart Turner Ltd, Henley-on-Thames, Oxfordshire RG9 2AD Tel: +44 (0) 1491 572655 Fax: +44 (0) 1491 573704
 TechAssist Helpline +44 (0) 800 31 969 80
www.stuart-turner.co.uk

Pt. No. 100080 Issue 3322-01-01