

Qty. Description

1 **MAGNA3 40-120 F N**



Note! Product picture may differ from actual product

Product No.: [97924351](#)

The Grundfos MAGNA3 circulator pump is the ideal choice for almost any building project – old or new. With its unrivalled energy efficiency, all-encompassing range and built-in communication capabilities, MAGNA3 is ideal for engineers and specifiers looking to create high-performance heating and cooling systems.

The pump is maintenance-free due to the canned-rotor type design. This also means that pump and motor form an integral unit without shaft seal and with only two gaskets for sealing. The bearings are lubricated by the pumped liquid.

MAGNA3 features an intuitive display and allows you to connect wirelessly with the Grundfos GO Remote app, giving you access to advanced reporting and monitoring.

The pump includes fieldbus communication via CIM modules as well analog and digital inputs and configurable relays.

Control features include FLOWADAPT, which reduces the need for throttling valves, thus cutting costs on system components.

MAGNA3 is the superior choice for a wide range of heating and cooling applications, including:

- Mixing loops
- Heating surfaces
- Air conditioning surfaces
- Ground-source heat pump systems
- Smaller chiller applications.

MAGNA3 is a single-phase pump and characterised by having the controller and control display integrated in the control box. The pump also has a built-in differential-pressure and temperature sensor.

The pump housing is available in both cast-iron and stainless-steel versions. The composite rotor can be carbon-fibre reinforced, the bearing plate and rotor cladding are made of stainless steel and the stator housing is made of aluminium. The power electronics are air-cooled.

MAGNA3 incorporates a 4-pole synchronous, permanent-magnet motor (PM motor). This motor type is characterised by higher efficiency than a conventional asynchronous squirrel-cage motor. The pump speed is controlled by an integrated frequency converter.

Features:

- Vast communication options, including inputs, relays and fieldbus
- The most energy-efficient pump range within the industry
- Intelligent control functions
- Stainless-steel variant to accommodate domestic hot-water applications
- AutoAdapt
- FlowAdapt, which reduces the need for throttling valves, cutting costs on system components
- Proportional-pressure control
- Constant-pressure control
- Constant-temperature control
- Constant-flow control
- Differential-temperature control (requires an additional temperature sensor)
- Constant-curve duty
- Maximum and minimum curve duty
- Automatic night setback



Company name: Anchor Pumps Company Limited

Created by:

Phone:

Date: 25/11/2020

Qty.	Description
	<p>Heat energy monitor No external motor protection required Innovative clamp ring with only one screw enabling easy repositioning of the pump head Insulating shells supplied with single-head pumps for heating systems Large temperature range due to air-cooled electronics.</p>

97924351 MAGNA3 40-120 F N

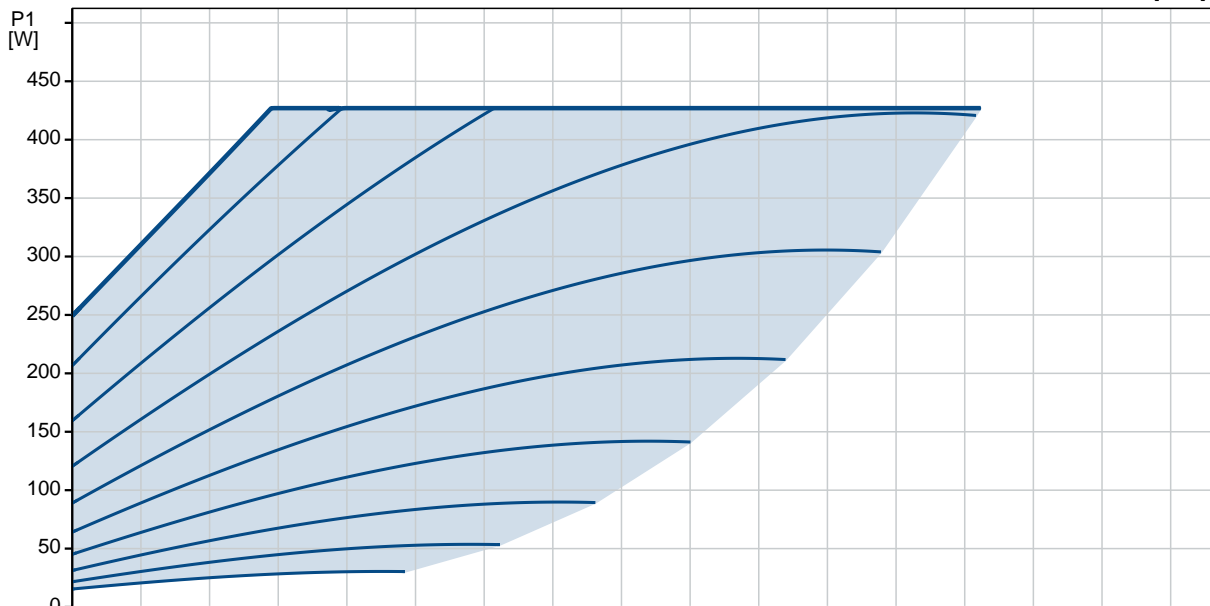
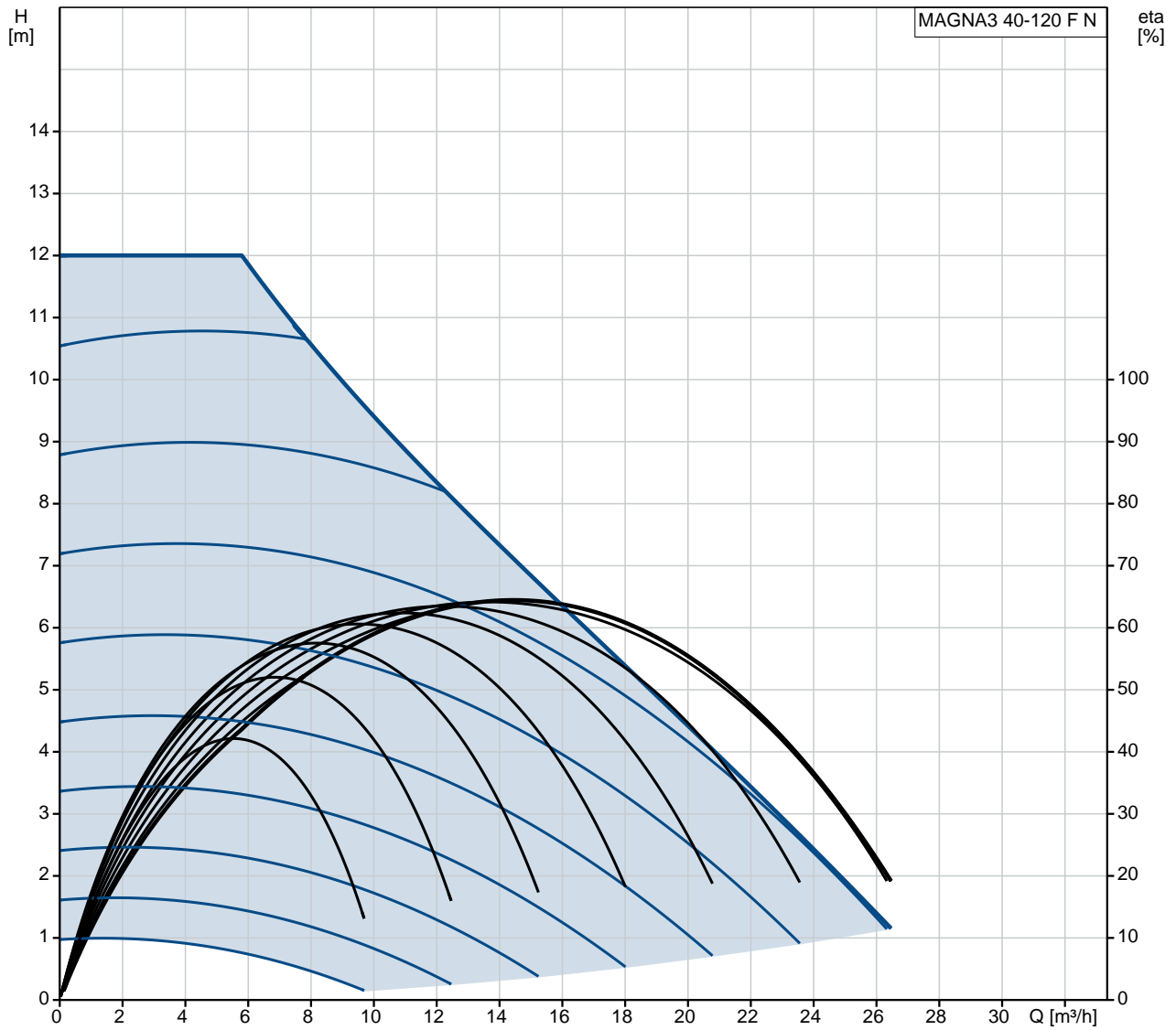

Description	Value
General information:	
Product name:	MAGNA3 40-120 F N
Product No:	97924351
EAN number:	5710626494279
Technical:	
Rated flow:	14.14 m ³ /h
Rated head:	7.263 m
Head max:	120 dm
TF class:	110
Approvals on nameplate:	CE, VDE, EAC, CN ROHS, WEEE
Model:	D
Materials:	
Pump housing:	Stainless steel
Pump housing:	EN 1.4308
Pump housing:	ASTM 351 CF8
Impeller:	PES 30%GF
Installation:	
Range of ambient temperature:	0 .. 40 °C
Maximum operating pressure:	10 bar
Flange standard:	DIN
Pipe connection:	DN 40
Pressure rating:	PN 6/10
Port-to-port length:	250 mm
Liquid:	
Pumped liquid:	Water
Liquid temperature range:	-10 .. 110 °C
Selected liquid temperature:	60 °C
Density:	983.2 kg/m ³
Electrical data:	
Power input - P1:	17 .. 427 W
Mains frequency:	50 / 60 Hz
Rated voltage:	1 x 230 V
Maximum current consumption:	0.19 .. 1.96 A
Enclosure class (IEC 34-5):	X4D
Insulation class (IEC 85):	F
Others:	
Energy (EEI):	0.18
Net weight:	16.7 kg
Gross weight:	18.2 kg
Shipping volume:	0.039 m ³
Danish VVS No.:	380982412
Swedish RSK No.:	5803218
Country of origin:	DE
Custom tariff no.:	84137030

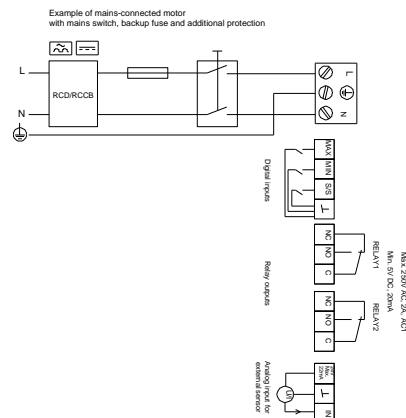
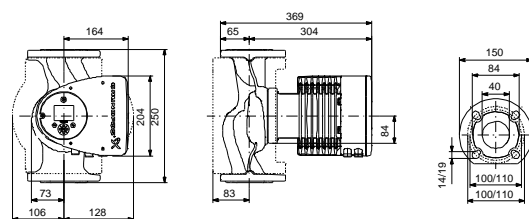
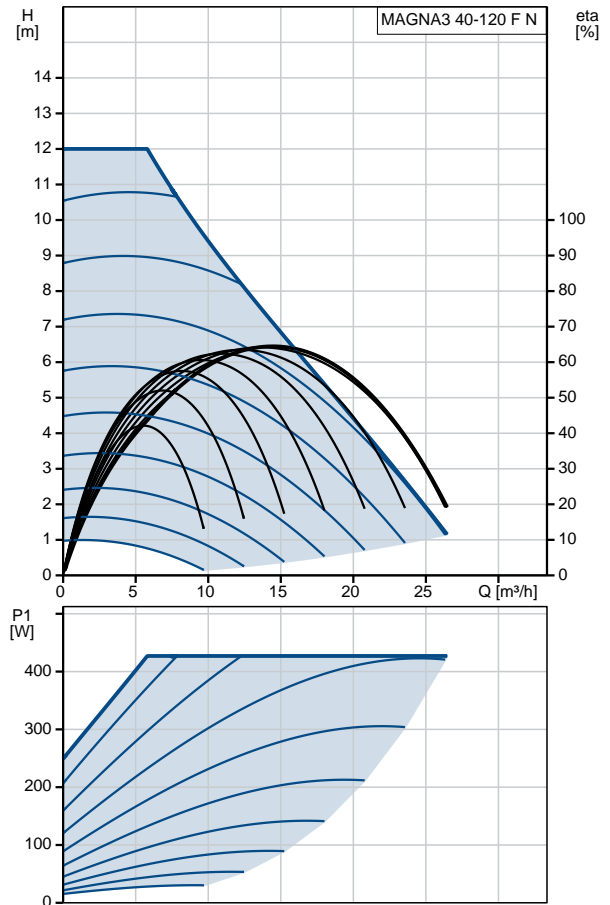

97924351 MAGNA3 40-120 F N

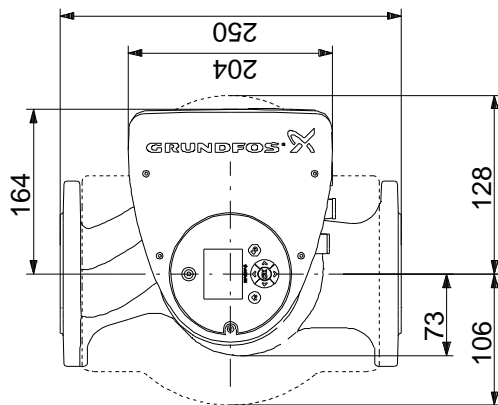
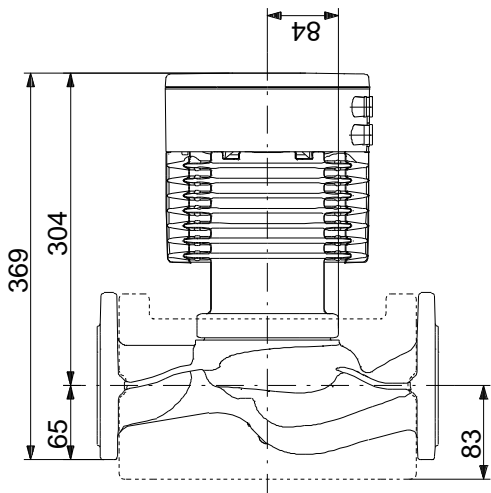
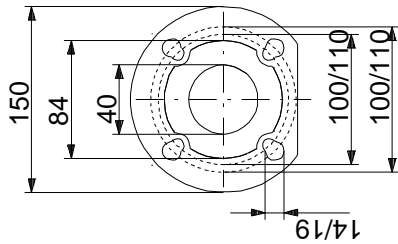

Note! All units are in [mm] unless others are stated.
Disclaimer: This simplified dimensional drawing does not show all details.

97924351 MAGNA3 40-120 F N

Example of mains-connected motor with mains switch, backup fuse and additional protection



Note! All units are in [mm] unless others are stated.