

Qty. Description

1 **MAGNA1 65-60 F N**



Note! Product picture may differ from actual product

Product No.: [99221395](#)

The new MAGNA1 is the simple option for a job well done. It is the perfect choice when replacing older circulators and due to its compliance with the EuP 2015 regulations, substantial savings on electricity is a reality. The ideal choice for basic performance needs in applications where basic system control and monitoring is desired.

- Monitoring via the fault relay, ensuring peace of mind
- Digital start/stop input available for remote pump control
- Continuous operation and reduced downtime with the wireless twin pump function (available on twin-head pumps)
- High energy efficiency resulting in substantial savings on electricity
- Easy setup and operation via the simple user interface
- No maintenance due to the canned-rotor type design.

MAGNA1 is the simple and efficient choice for most applications including

- Heating
 - Main pump
 - Mixing loops
 - Heating surfaces
- Cooling
 - Air conditioning surfaces
 - Ground source heat pump systems
 - Smaller chiller applications

Liquid:

Pumped liquid: Water
 Liquid temperature range: -10 .. 110 °C
 Selected liquid temperature: 60 °C
 Density: 983.2 kg/m³

Technical:

TF class: 110
 Approvals on nameplate: CE,VDE,EAC,CN ROHS,WEEE

Materials:

Pump housing: Stainless steel
 EN 1.4308
 ASTM 351 CF8
 Impeller: PES 30%GF

Installation:

Range of ambient temperature: 0 .. 40 °C
 Maximum operating pressure: 10 bar
 Flange standard: DIN
 Pipe connection: DN 65
 Pressure rating: PN 6/10
 Port-to-port length: 340 mm



Company name: Anchor Pumps Company Limited

Created by:

Phone:

Date: 18/11/2020

Qty.	Description																								
	<p>Electrical data:</p> <table><tr><td>Power input - P1:</td><td>23.15 .. 365 W</td></tr><tr><td>Mains frequency:</td><td>50 / 60 Hz</td></tr><tr><td>Rated voltage:</td><td>1 x 230 V</td></tr><tr><td>Maximum current consumption:</td><td>0.24 .. 1.64 A</td></tr><tr><td>Enclosure class (IEC 34-5):</td><td>X4D</td></tr><tr><td>Insulation class (IEC 85):</td><td>F</td></tr></table> <p>Others:</p> <table><tr><td>Energy (EEI):</td><td>0.20</td></tr><tr><td>Net weight:</td><td>21.8 kg</td></tr><tr><td>Gross weight:</td><td>23.7 kg</td></tr><tr><td>Shipping volume:</td><td>0.057 m³</td></tr><tr><td>Country of origin:</td><td>DE</td></tr><tr><td>Custom tariff no.:</td><td>84137030</td></tr></table>	Power input - P1:	23.15 .. 365 W	Mains frequency:	50 / 60 Hz	Rated voltage:	1 x 230 V	Maximum current consumption:	0.24 .. 1.64 A	Enclosure class (IEC 34-5):	X4D	Insulation class (IEC 85):	F	Energy (EEI):	0.20	Net weight:	21.8 kg	Gross weight:	23.7 kg	Shipping volume:	0.057 m ³	Country of origin:	DE	Custom tariff no.:	84137030
Power input - P1:	23.15 .. 365 W																								
Mains frequency:	50 / 60 Hz																								
Rated voltage:	1 x 230 V																								
Maximum current consumption:	0.24 .. 1.64 A																								
Enclosure class (IEC 34-5):	X4D																								
Insulation class (IEC 85):	F																								
Energy (EEI):	0.20																								
Net weight:	21.8 kg																								
Gross weight:	23.7 kg																								
Shipping volume:	0.057 m ³																								
Country of origin:	DE																								
Custom tariff no.:	84137030																								

99221395 MAGNA1 65-60 F N

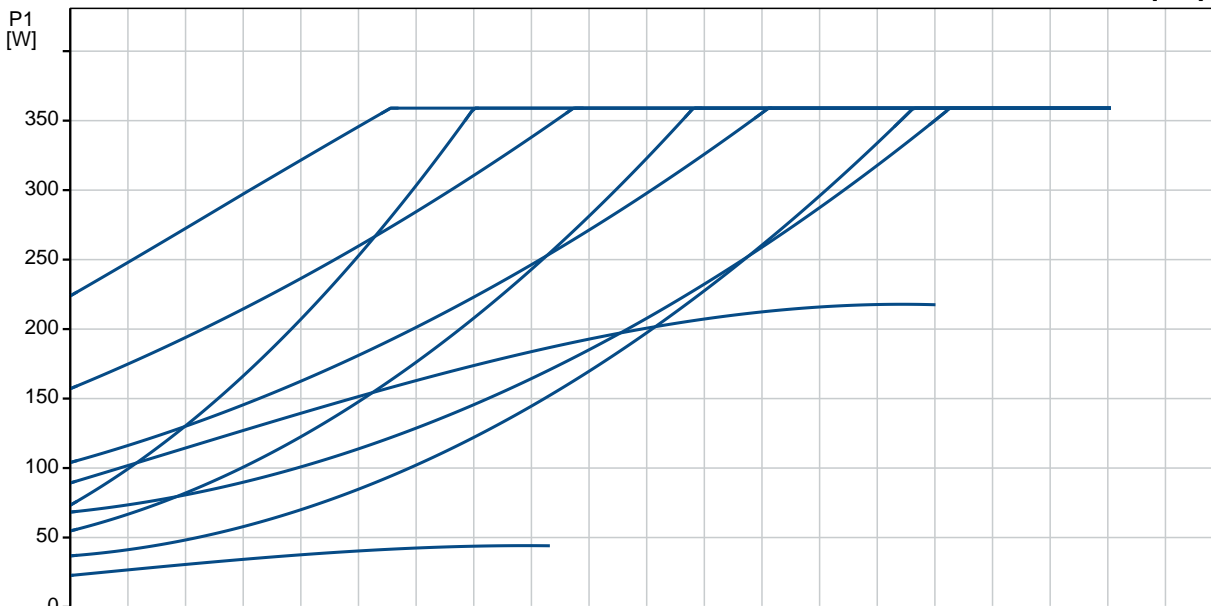
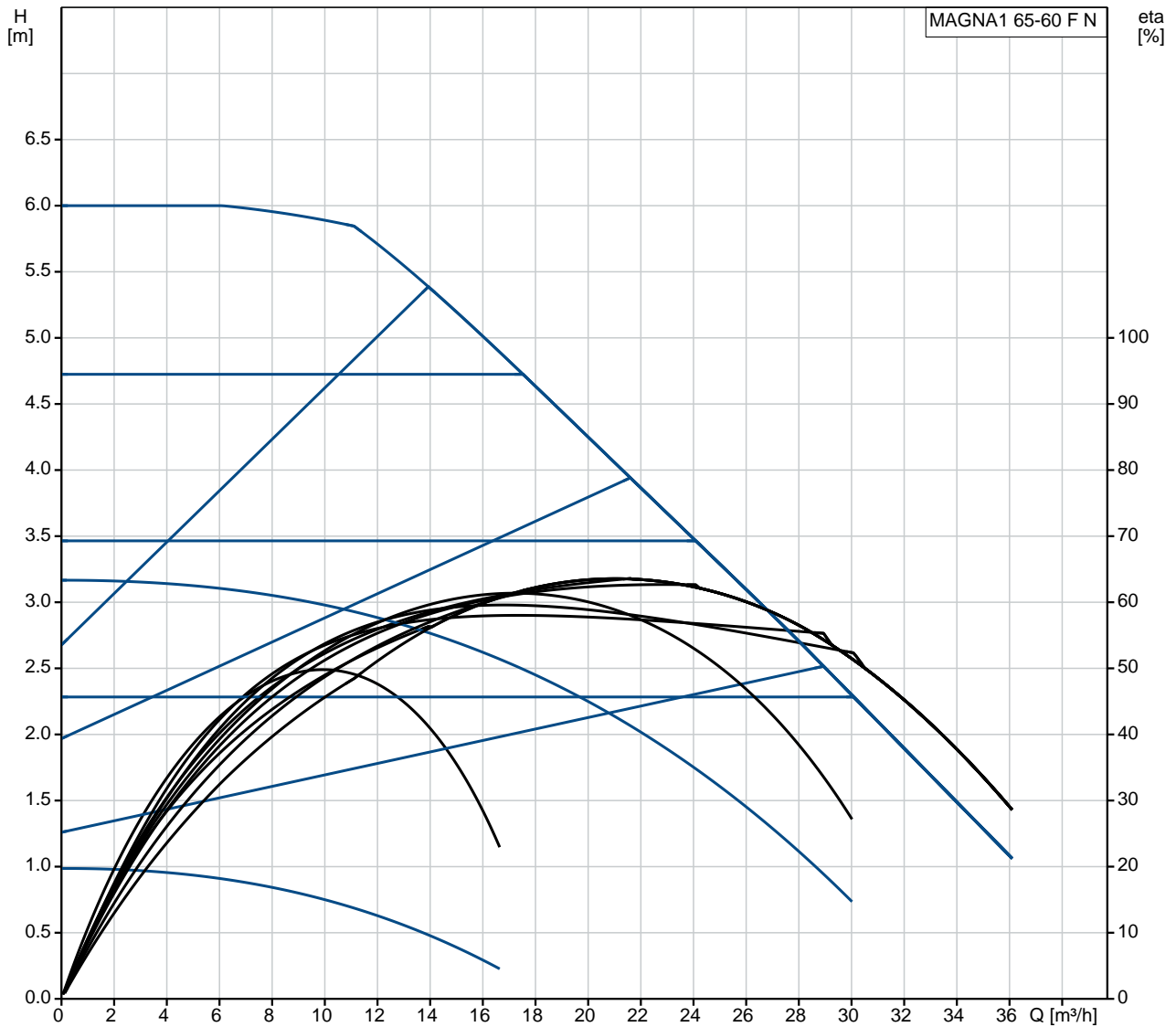

99221395 MAGNA1 65-60 F N

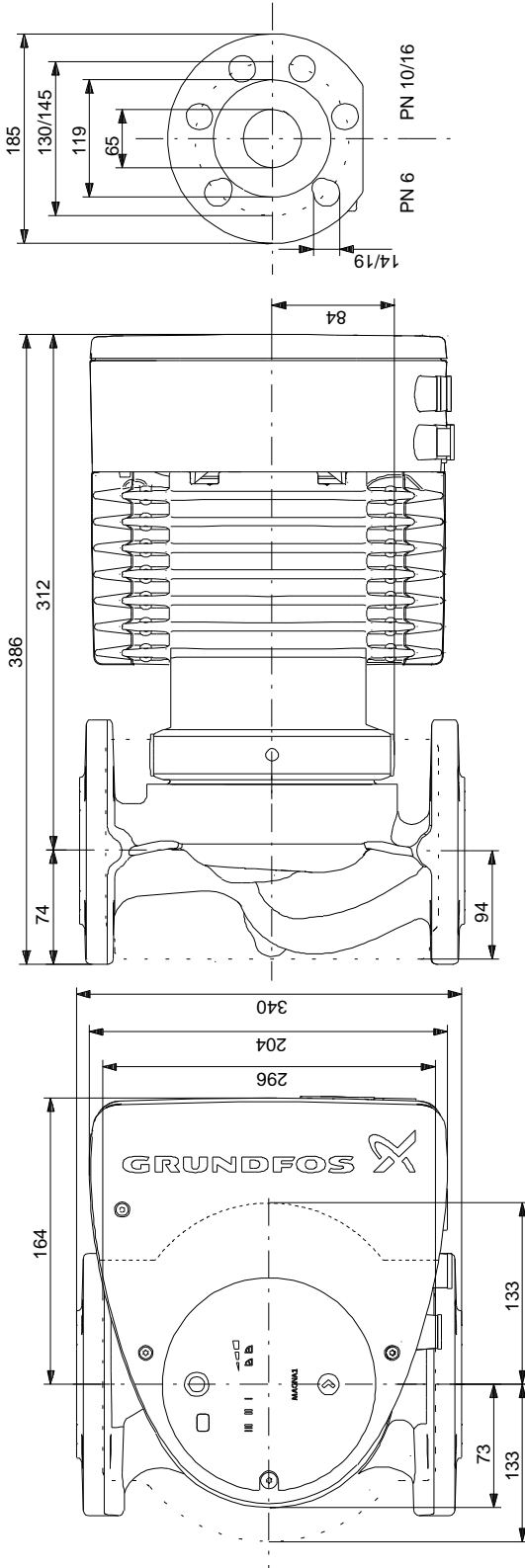

Note! All units are in [mm] unless others are stated.
 Disclaimer: This simplified dimensional drawing does not show all details.

99221395 MAGNA1 65-60 F N

Example of mains-connected motor with mains switch, backup fuse and additional protection

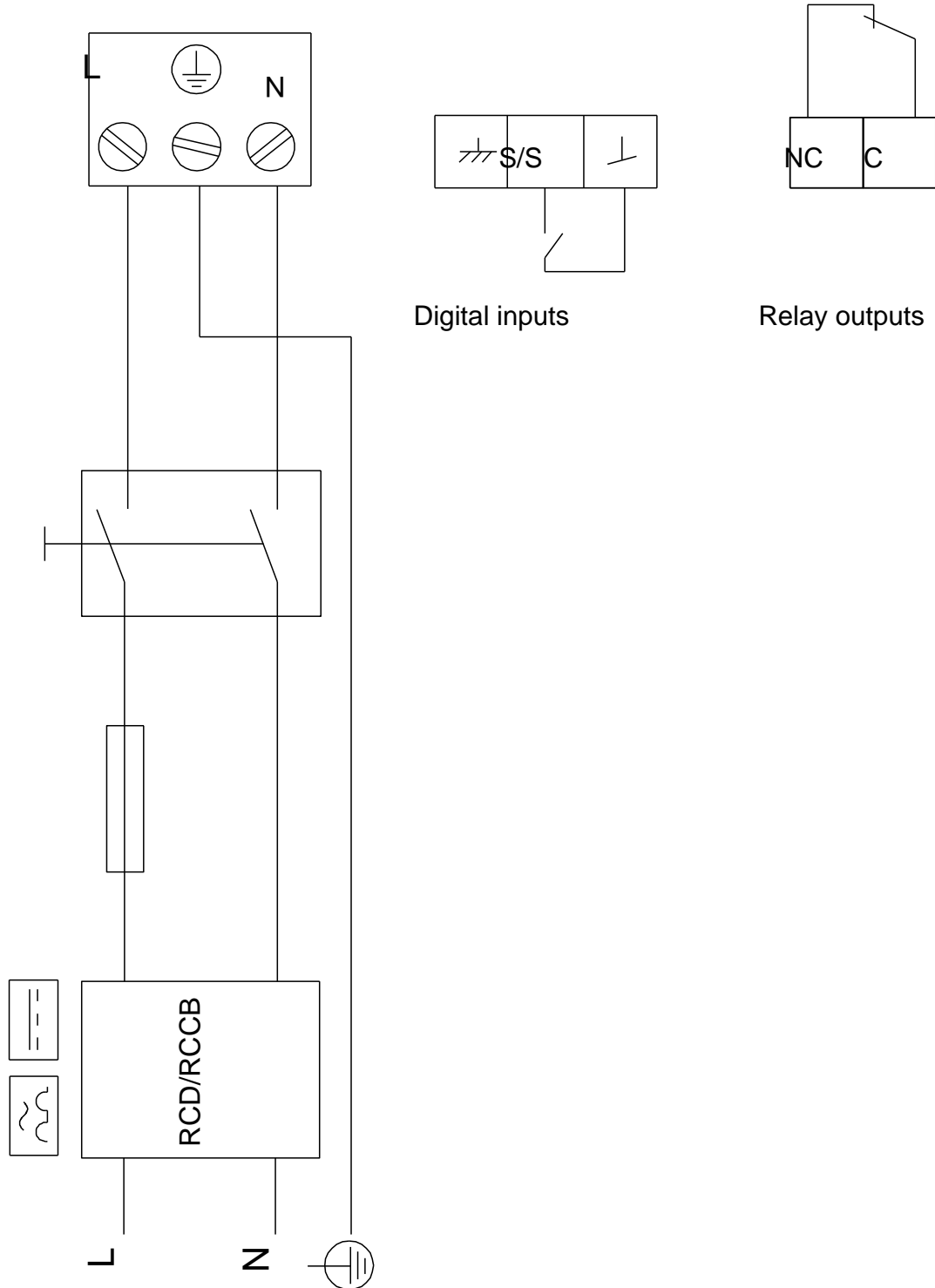

Digital inputs

Relay outputs

Note! All units are in [mm] unless others are stated.