

Qty. Description

1 **MAGNA1 50-180 F N**



Note! Product picture may differ from actual product

Product No.: [99221363](#)

The new MAGNA1 is the simple option for a job well done. It is the perfect choice when replacing older circulators and due to its compliance with the EuP 2015 regulations, substantial savings on electricity is a reality. The ideal choice for basic performance needs in applications where basic system control and monitoring is desired.

- Monitoring via the fault relay, ensuring peace of mind
- Digital start/stop input available for remote pump control
- Continuous operation and reduced downtime with the wireless twin pump function (available on twin-head pumps)
- High energy efficiency resulting in substantial savings on electricity
- Easy setup and operation via the simple user interface
- No maintenance due to the canned-rotor type design.

MAGNA1 is the simple and efficient choice for most applications including

- Heating
 - Main pump
 - Mixing loops
 - Heating surfaces
- Cooling
 - Air conditioning surfaces
 - Ground source heat pump systems
 - Smaller chiller applications

Liquid:

Pumped liquid: Water
 Liquid temperature range: -10 .. 110 °C
 Selected liquid temperature: 60 °C
 Density: 983.2 kg/m³

Technical:

TF class: 110
 Approvals on nameplate: CE,VDE,EAC,CN ROHS,WEEE

Materials:

Pump housing: Stainless steel
 EN 1.4308
 ASTM 351 CF8
 Impeller: PES 30%GF

Installation:

Range of ambient temperature: 0 .. 40 °C
 Maximum operating pressure: 10 bar
 Flange standard: DIN
 Pipe connection: DN 50
 Pressure rating: PN 6/10
 Port-to-port length: 280 mm



Company name: Anchor Pumps Company Limited

Created by:

Phone:

Date: 17/11/2020

Qty.	Description
------	-------------

Electrical data:	
Power input - P1:	22.13 .. 769 W
Mains frequency:	50 / 60 Hz
Rated voltage:	1 x 230 V
Maximum current consumption:	0.24 .. 3.4 A
Enclosure class (IEC 34-5):	X4D
Insulation class (IEC 85):	F

Others:	
Energy (EEI):	0.20
Net weight:	19.8 kg
Gross weight:	21.4 kg
Shipping volume:	0.046 m ³
Country of origin:	DE
Custom tariff no.:	84137030

99221363 MAGNA1 50-180 F N

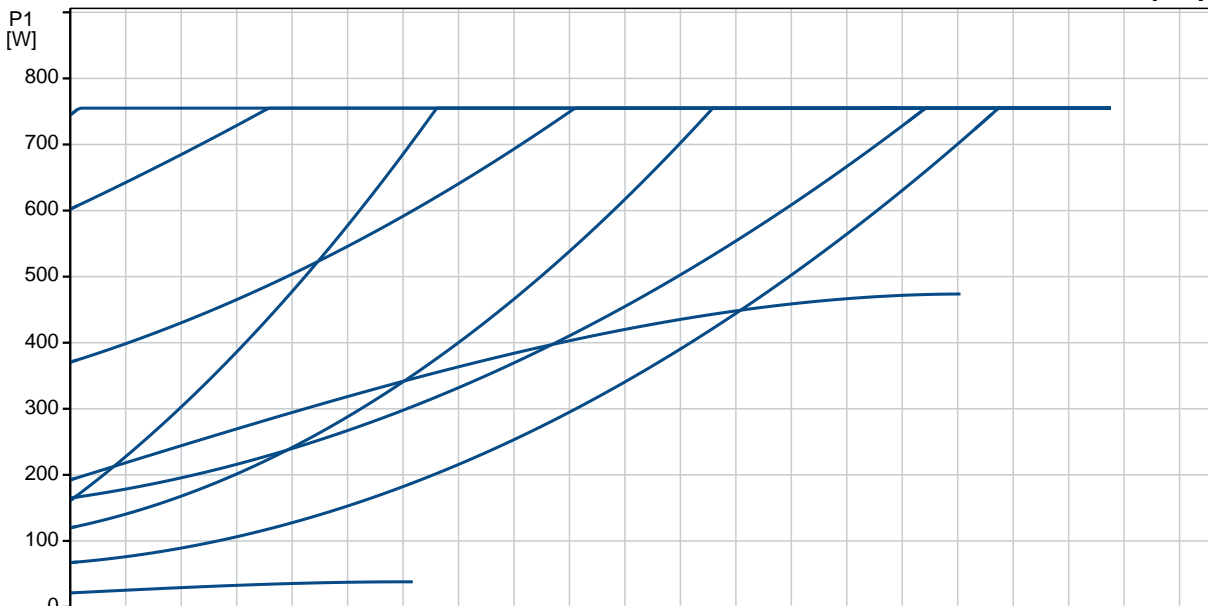
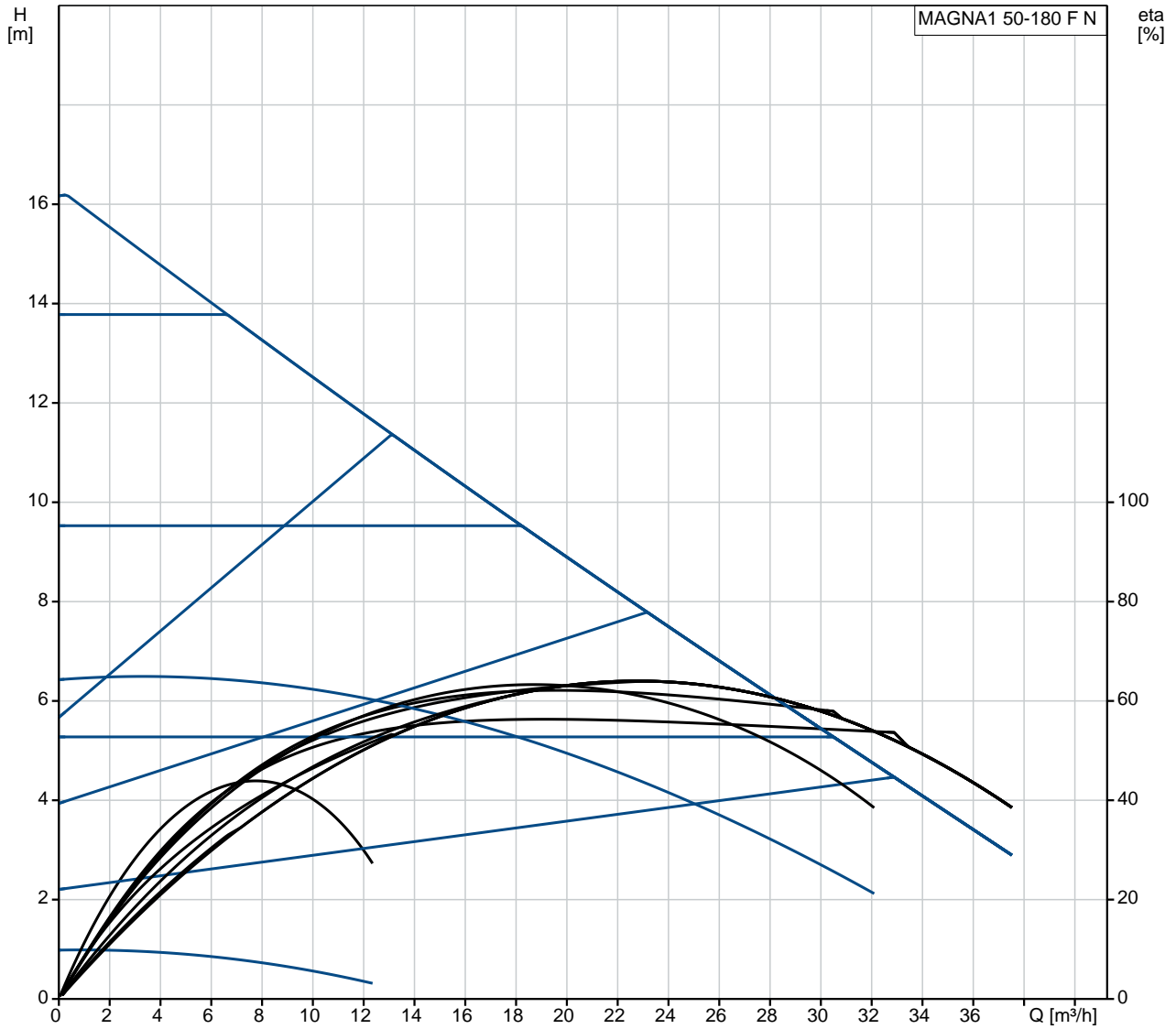

Description	Value
General information:	
Product name:	MAGNA1 50-180 F N
Product No:	99221363
EAN number:	5712608943355
Technical:	
Head max:	180 dm
TF class:	110
Approvals on nameplate:	CE,VDE,EAC,CN ROHS,WEEE
Model:	C
Materials:	
Pump housing:	Stainless steel
Pump housing:	EN 1.4308
Pump housing:	ASTM 351 CF8
Impeller:	PES 30%GF
Installation:	
Range of ambient temperature:	0 .. 40 °C
Maximum operating pressure:	10 bar
Flange standard:	DIN
Pipe connection:	DN 50
Pressure rating:	PN 6/10
Port-to-port length:	280 mm
Liquid:	
Pumped liquid:	Water
Liquid temperature range:	-10 .. 110 °C
Selected liquid temperature:	60 °C
Density:	983.2 kg/m ³
Electrical data:	
Power input - P1:	22.13 .. 769 W
Mains frequency:	50 / 60 Hz
Rated voltage:	1 x 230 V
Maximum current consumption:	0.24 .. 3.4 A
Enclosure class (IEC 34-5):	X4D
Insulation class (IEC 85):	F
Others:	
Energy (EEI):	0.20
Net weight:	19.8 kg
Gross weight:	21.4 kg
Shipping volume:	0.046 m ³
Country of origin:	DE
Custom tariff no.:	84137030

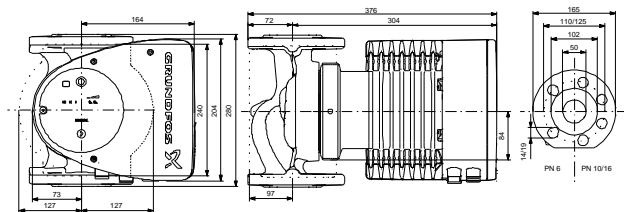
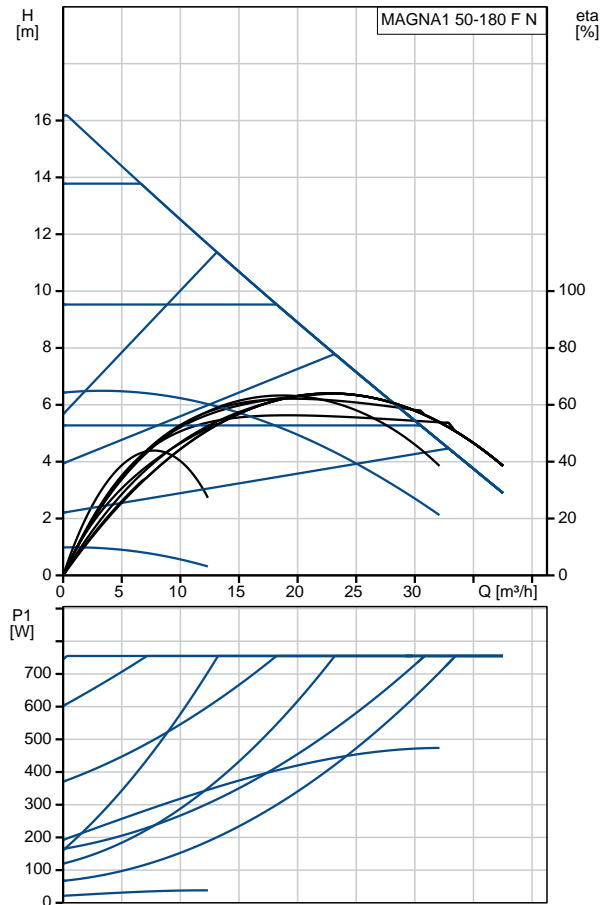

Example of mains-connected motor with mains switch, backup fuse and additional protection

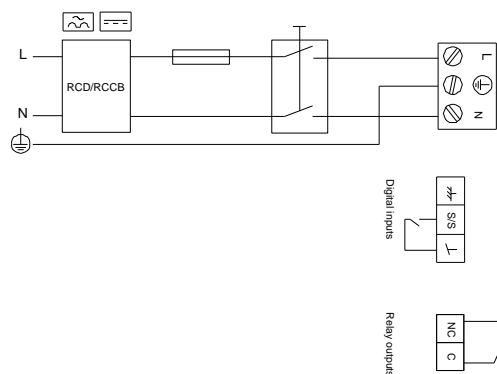

99221363 MAGNA1 50-180 F N

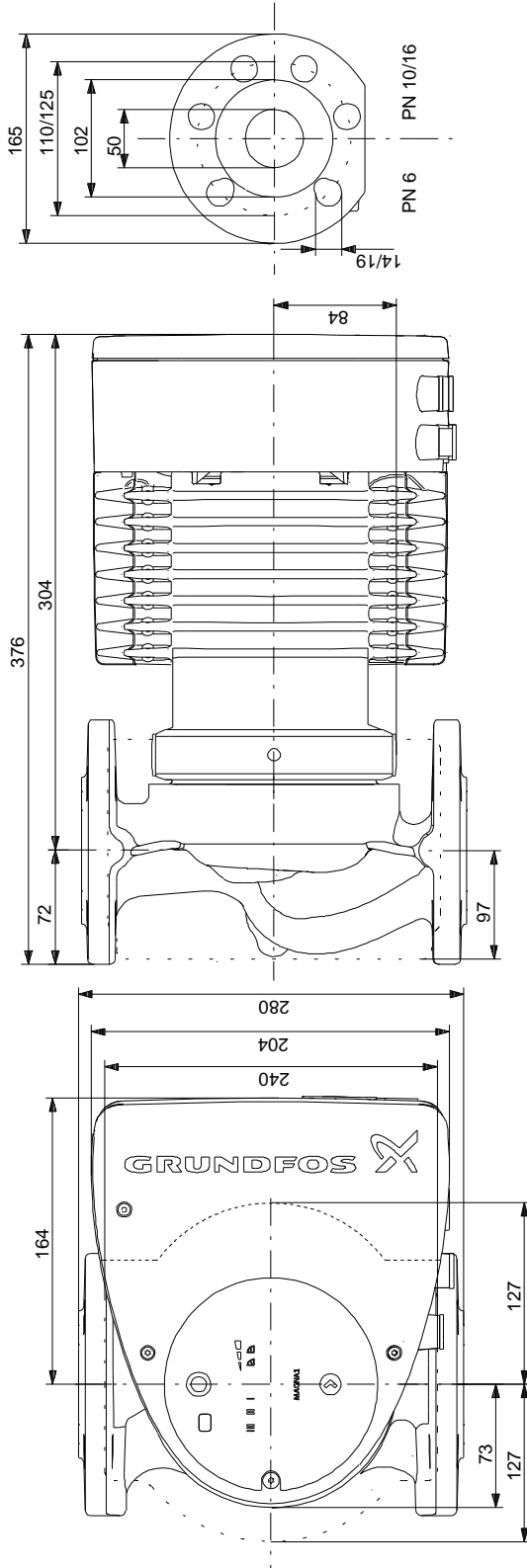

Note! All units are in [mm] unless others are stated.
Disclaimer: This simplified dimensional drawing does not show all details.

99221363 MAGNA1 50-180 F N

Example of mains-connected motor with mains switch, backup fuse and additional protection

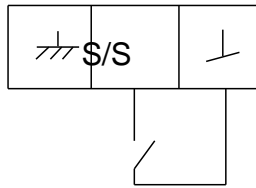
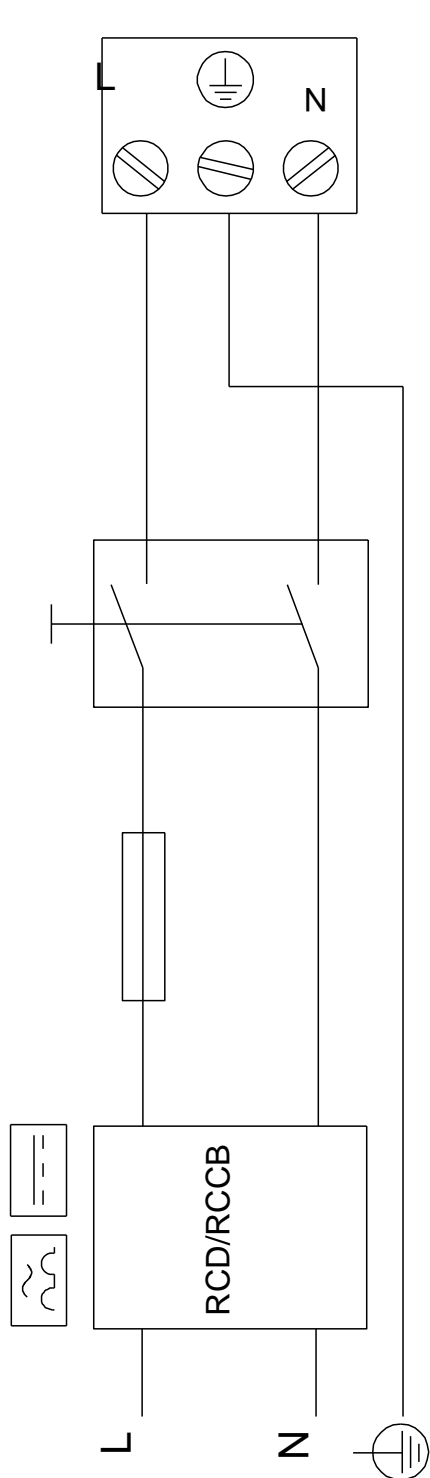

Digital inputs

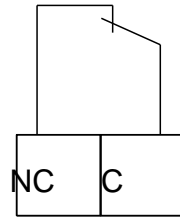

Relay outputs

Note! All units are in [mm] unless others are stated.