

Installation, Operation,
and Maintenance Manual

HYDROVAR®

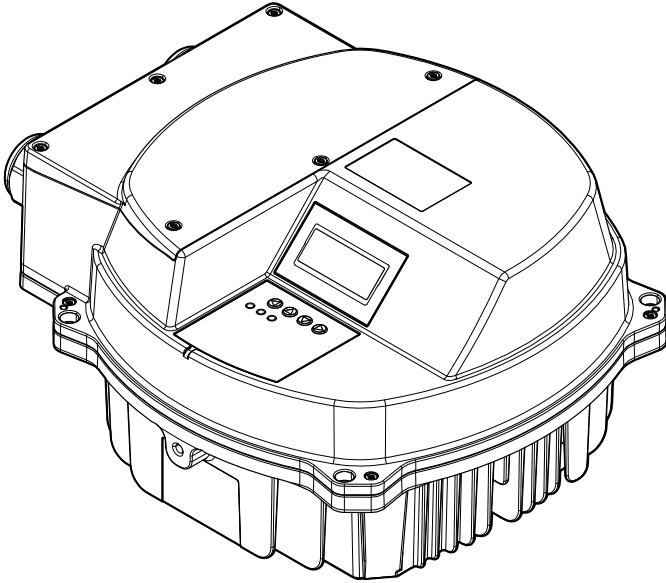

HVL 2.015-4.220

xylem
Let's Solve Water

Table of Contents

1 Introduction and Safety	4
1.1 Introduction.....	4
1.1.1 Qualified personnel.....	4
1.2 Safety.....	4
1.2.1 Safety message levels.....	5
1.3 User safety.....	5
1.4 Protecting the environment.....	7
1.5 Warranty.....	7
1.6 Spare parts.....	7
1.7 EU declaration of conformity (No LVD/EMCD05).....	8
1.8 EU declaration of conformity.....	8
2 Transportation and Storage	10
2.1 Inspect the delivery.....	10
2.1.1 Inspect the package.....	10
2.1.2 Inspect the unit.....	10
2.2 System lifting.....	10
2.3 Transportation guidelines.....	11
2.4 Storage guidelines.....	11
3 Product Description	12
3.1 System description.....	12
3.2 Product function and use.....	13
3.3 Applications.....	13
3.3.1 Actuator.....	13
3.3.2 Controller.....	13
3.3.3 Cascade serial / Synchronous.....	13
3.3.4 Cascade relay.....	14
3.4 The data plate.....	14
3.5 Technical Data.....	15
3.6 Motor thermal protection.....	16
3.7 Dimensions and weights.....	17
3.8 Design and layout.....	18
3.9 Included mounting components.....	20
3.10 Optional components.....	21
4 Installation	22
4.1 Installation site checklist.....	22
4.2 Frequency converter and motor pre-installation check list.....	22
5 Mechanical Installation	23
5.1 Cooling.....	23
5.2 Lifting.....	23
5.3 Mounting.....	23
6 Electrical Installation	26
6.1 Precautions.....	26
6.2 Protection devices.....	27
6.3 Wire type and ratings.....	29
6.4 EMC compatibility.....	30

6.4.1 EMC requirements.....	30
6.4.2 Wiring the cables.....	30
6.4.3 RFI switch.....	31
6.5 AC mains and motor connection terminals.....	32
6.5.1 AC Mains (power supply) connection.....	32
6.5.2 Motor connection.....	33
6.6 Control terminals.....	34
6.6.1 Motor sensor connection.....	35
6.6.2 Input for emergency basic operations.....	36
6.6.3 Digital and analog I/O.....	36
6.6.4 RS485 connection.....	37
6.6.5 Status relays.....	37
6.7 Premium card terminals.....	38
6.7.1 Digital and analog I/O (X3).....	38
6.7.2 Relays (X4).....	38
7 Operation.....	40
7.1 Pre-start procedure.....	40
7.2 Pre-startup inspections.....	40
7.3 Apply power.....	41
7.4 Discharge time.....	41
8 Programming.....	43
8.1 Display and control panel.....	43
8.2 Functions of push buttons.....	43
8.3 Software parameters.....	44
8.3.1 M00 MAIN MENU.....	45
8.3.2 M20 STATUS.....	49
8.3.3 M40 DIAGNOSTICS.....	52
8.3.4 M60 SETTINGS.....	54
8.3.5 M100 BASIC SETTINGS.....	55
8.3.6 M200 CONF.INVERTER.....	57
8.3.7 M300 REGULATION.....	69
8.3.8 M400 SENSOR.....	71
8.3.9 M500 SEQUENCE CONTR.....	74
8.3.10 M600 ERROR.....	78
8.3.11 M700 OUTPUTS.....	79
8.3.12 M800 REQUIRED VALUES.....	81
8.3.13 M900 OFFSET.....	83
8.3.14 M1000 TEST RUN.....	86
8.3.15 M1100 SETUP.....	87
8.3.16 M1200 RS-485 INTERFACE.....	89
8.3.17 M1300 START-UP.....	92
9 Maintenance.....	98
9.1 General.....	98
9.2 Check error codes.....	98
9.3 Check the functions and parameters.....	98
10 Troubleshooting.....	99
10.1 No error message on the display.....	99
10.2 Error message on the display.....	99
10.3 Internal error, on display or red LED ON.....	101
11 Technical Reference.....	102
11.1 Example: P105 ACTUATOR mode.....	102

11.2 Example: P200 Ramp Settings.....	102
11.3 Example: P330 LIFT AMOUNT.....	103
11.4 Example: P500 SUBMENU SEQUENCE CNTR.....	104
11.5 Example: P900 SUBMENU OFFSET.....	105
11.6 Programming flow charts.....	107

1 Introduction and Safety

1.1 Introduction

Purpose of this manual

The purpose of this manual is to provide necessary information for:

- Installation
- Operation
- Maintenance



CAUTION:

Read this manual carefully before installing and using the product. Improper use of the product can cause personal injury and damage to property, and may void the warranty.

NOTICE:

Save this manual for future reference, and keep it readily available at the location of the unit.

1.1.1 Qualified personnel



WARNING:

This product is intended to be operated by qualified personnel only.

- Correct and reliable transport, storage, installation, operation, and maintenance are required for the trouble-free and safe operation of the frequency converter. Only qualified personnel are allowed to install or operate this equipment.
- Qualified personnel are defined as trained staff, who are authorized to install, commission, and maintain equipment, systems, and circuits in accordance with pertinent laws and regulations. Also, the personnel must be familiar with the instructions and safety measures that are described in this document.
- Persons with diminished capacities should not operate the product unless they are supervised or have been properly trained by a professional.
- Children must be supervised to ensure that they do not play on or around the product.

1.2 Safety



WARNING:

- The operator must be aware of safety precautions to prevent physical injury.
 - Operating, installing, or maintaining the unit in any way that is not covered in this manual could cause death, serious personal injury, or damage to the equipment. This includes any modification to the equipment or use of parts not provided by Xylem. If there is a question regarding the intended use of the equipment, please contact a Xylem representative before proceeding.
 - Do not change the service application without the approval of an authorized Xylem representative.
-



CAUTION:

You must observe the instructions contained in this manual. Failure to do so could result in physical injury, damage, or delays.





1.2.1 Safety message levels

About safety messages

It is extremely important that you read, understand, and follow the safety messages and regulations carefully before handling the product. They are published to help prevent these hazards:

- Personal accidents and health problems
- Damage to the product
- Product malfunction

Definitions

Safety message level	Indication
 DANGER:	A hazardous situation which, if not avoided, will result in death or serious injury
 WARNING:	A hazardous situation which, if not avoided, could result in death or serious injury
 CAUTION:	A hazardous situation which, if not avoided, could result in minor or moderate injury
 Electrical Hazard:	The possibility of electrical risks if instructions are not followed in a proper manner
NOTICE:	<ul style="list-style-type: none"> • A potential situation which, if not avoided, could result in undesirable conditions • A practice not related to personal injury

Hot surface hazard

Hot surface hazards are indicated by a specific symbol that replaces the typical hazard level symbols:



CAUTION:

1.3 User safety

General safety rules

These safety rules apply:

- Always keep the work area clean.
- Pay attention to the risks presented by gas and vapors in the work area.
- Avoid all electrical dangers. Pay attention to the risks of electric shock or arc flash hazards.
- Always bear in mind the risk of drowning, electrical accidents, and burn injuries.

Safety equipment

Use safety equipment according to the company regulations. Use this safety equipment within the work area:

- Hard hat
- Safety goggles, preferably with side shields
- Protective shoes
- Protective gloves
- Gas mask
- Hearing protection
- First-aid kit
- Safety devices

NOTICE:

Never operate a unit unless safety devices are installed. Also see specific information about safety devices in other chapters of this manual.

Electrical connections

Electrical connections must be made by certified electricians in compliance with all international, national, state, and local regulations. For more information about requirements, see sections dealing specifically with electrical connections.

Precautions before work

Observe these safety precautions before you work with the product or are in connection with the product:

- Provide a suitable barrier around the work area, for example, a guard rail.
- Make sure that all safety guards are in place and secure.
- Make sure that you have a clear path of retreat.
- Make sure that the product cannot roll or fall over and injure people or damage property.
- Make sure that the lifting equipment is in good condition.
- Use a lifting harness, a safety line, and a breathing device as required.
- Allow all system and pump components to cool before you handle them.
- Make sure that the product has been thoroughly cleaned.
- Disconnect and lock out power before you service the pump.
- Check the explosion risk before you weld or use electric hand tools.

Precautions during work

Observe these safety precautions when you work with the product or are in connection with the product:

- Never work alone.
- Always wear protective clothing and hand protection.
- Stay clear of suspended loads.
- Always lift the product by its lifting device.
- Beware of the risk of a sudden start if the product is used with an automatic level control.
- Beware of the starting jerk, which can be powerful.
- Rinse the components in water after you disassemble the pump.
- Do not exceed the maximum working pressure of the pump.
- Do not open any vent or drain valve or remove any plugs while the system is pressurized. Make sure that the pump is isolated from the system and that pressure is relieved before you disassemble the pump, remove plugs, or disconnect piping.
- Never operate a pump without a properly installed coupling guard.

Wash the skin and eyes

Follow these procedures for chemicals or hazardous fluids that have come into contact with your eyes or your skin:

Condition	Action
Chemicals or hazardous fluids in eyes	<ol style="list-style-type: none"> 1. Hold your eyelids apart forcibly with your fingers. 2. Rinse the eyes with eyewash or running water for at least 15 minutes. 3. Seek medical attention.
Chemicals or hazardous fluids on skin	<ol style="list-style-type: none"> 1. Remove contaminated clothing. 2. Wash the skin with soap and water for at least 1 minute. 3. Seek medical attention, if necessary.

1.4 Protecting the environment

Emissions and waste disposal

Observe the local regulations and codes regarding:

- Reporting of emissions to the appropriate authorities
- Sorting, recycling and disposal of solid or liquid waste
- Clean-up of spills

Exceptional sites



CAUTION: Radiation Hazard

Do NOT send the product to Xylem if it has been exposed to nuclear radiation, unless Xylem has been informed and appropriate actions have been agreed upon.

Recycling guidelines

Always follow local laws and regulations regarding recycling.

Waste and emissions guidelines

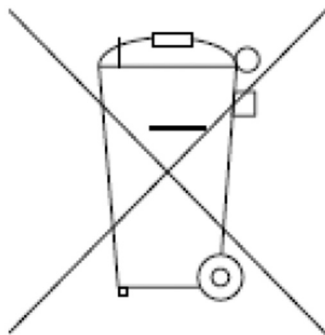

Do not dispose of equipment containing electrical components together with domestic waste.

Collect it separately in accordance with local and currently valid legislation.

1.5 Warranty

For information about warranty, see the sales contract.

1.6 Spare parts



WARNING:

Only use original spare parts to replace any worn or faulty components. The use of unsuitable spare parts may cause malfunctions, damage, and injuries as well as void the guarantee.

For more information about the product's spare parts, refer to the Sales and Service department.

1.7 EU declaration of conformity (No LVD/EMCD05)

1. Apparatus model/Product: → data plate
2. Name and address of the manufacturer: Xylem Service Italia S.r.l.
Via Vittorio Lombardi 14
36100 Vicenza VI
Italy
3. This declaration of conformity is issued under the sole responsibility of the manufacturer.
4. Object of the declaration: Frequency converter (variable speed drive) HYDROVAR® for electric pump in one of the following models
- | | |
|----------------|----------------|
| HVL2.015-A0010 | HVL4.015-A0010 |
| HVL2.022-A0010 | HVL4.022-A0010 |
| HVL2.030-A0010 | HVL4.030-A0010 |
| HVL2.040-A0010 | HVL4.040-A0010 |
| HVL3.015-A0010 | HVL4.055-A0010 |
| HVL3.022-A0010 | HVL4.075-A0010 |
| HVL3.030-A0010 | HVL4.110-A0010 |
| HVL3.040-A0010 | HVL4.150-A0010 |
| HVL3.055-A0010 | HVL4.185-A0010 |
| HVL3.075-A0010 | HVL4.220-A0010 |
| HVL3.110-A0010 | |
5. The object of the declaration described above is in conformity with the relevant Union harmonisation legislation:
- Directive 2014/35/UE of 26 February 2014 (electrical equipment designed for use within certain voltage limits)
 - Directive 2014/30/UE of 26 February 2014 (electromagnetic compatibility)
6. References to the relevant harmonised standards used or references to the other technical specifications in relation to which conformity is declared:
- EN 61800-5-1:2007
 - EN 61800-3:2004+A1:2012 (*), EN 61000-6-1:2007, EN 61000-6-2:2005, EN 61000-6-4:2007+A1:2011
- (*) Category C3
7. Notified body: -
8. Additional information: -
- Signed for and on behalf of: Xylem Service Italia S.r.l.
Montecchio Maggiore, 18/04/2016
Amedeo Valente
Director of Engineering and R&D
Rev. 00
- 

1.8 EU declaration of conformity

1. Unique identification of the EEE: No HVL
2. Name and address of the manufacturer: Xylem Service Italia S.r.l.
Via Vittorio Lombardi 14
36100 Vicenza VI
Italy
3. This declaration of conformity is issued under the sole responsibility of the manufacturer.

4. Object of the declaration:	Frequency converter (variable speed drive) HYDROVAR® for electric pump in one of the following models	
	HVL2.015-A0010	HVL4.015-A0010
	HVL2.022-A0010	HVL4.022-A0010
	HVL2.030-A0010	HVL4.030-A0010
	HVL2.040-A0010	HVL4.040-A0010
	HVL3.015-A0010	HVL4.055-A0010
	HVL3.022-A0010	HVL4.075-A0010
	HVL3.030-A0010	HVL4.110-A0010
	HVL3.040-A0010	HVL4.150-A0010
	HVL3.055-A0010	HVL4.185-A0010
	HVL3.075-A0010	HVL4.220-A0010
	HVL3.110-A0010	

5. The object of the declaration described above is in conformity with Directive 2011/65/EU of the European Parliament and of the Council of 8 June 2011 on the restriction of the use of certain hazardous substances in electrical and electronic equipment.

6. References to the relevant harmonised standards used or references to the other technical specifications in relation to which conformity is declared: -

7. Additional information: -

Signed for and on behalf of:
Montecchio Maggiore, 18/04/2016
Amedeo Valente
Director of Engineering and R&D
Rev. 01

Xylem Service Italia S.r.l.



2 Transportation and Storage

2.1 Inspect the delivery

2.1.1 Inspect the package

1. Inspect the package for damaged or missing items upon delivery.
2. Note any damaged or missing items on the receipt and freight bill.
3. File a claim with the shipping company if anything is out of order.
If the product has been picked up at a distributor, make a claim directly to the distributor.

2.1.2 Inspect the unit

1. Remove packing materials from the product.
Dispose of all packing materials in accordance with local regulations.
2. Inspect the product to determine if any parts have been damaged or are missing.
3. If applicable, unfasten the product by removing any screws, bolts, or straps.
For your personal safety, be careful when you handle nails and straps.
4. Contact the local sales representative if there is any issue.

2.2 System lifting



WARNING:

Assembled units and their components are heavy. Failure to properly lift and support this equipment can result in serious physical injury and/or equipment damage. Lift equipment only at the specifically identified lifting points. Lifting devices such as eyebolts, slings, and spreaders must be rated, selected, and used for the entire load being lifted.



WARNING: Crush Hazard

1) Always lift the unit by its designated lifting points. 2) Use suitable lifting equipment and ensure that the product is properly harnessed. 3) Wear personal protective equipment. 4) Stay clear of cables and suspended loads.

Lifting diagrams

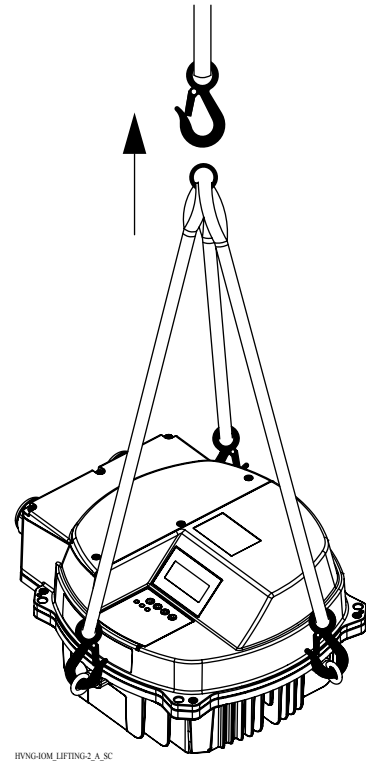
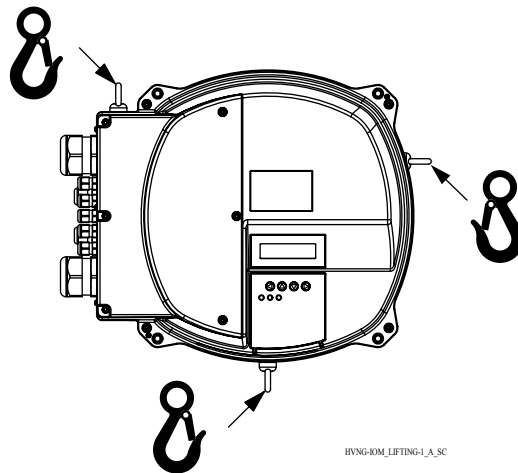

2.3 Transportation guidelines

Precautions



WARNING:

- Stay clear of suspended loads.
 - Observe accident prevention regulations in force.
 - Do not damage the cables during transport; do not squeeze, bend or drag the cable.
 - Always keep the cable ends dry.
 - Secure the unit against tipping over and slipping until it is mounted and fixed in its final location.
 - Lift and handle the product carefully, using suitable lifting equipment (stacker, crane, crane mounting device, lifting blocks, sling ropes, etc.).
 - Always lift the unit by its lifting handle. Never lift the unit by the motor cable or by the hose.
-

2.4 Storage guidelines

Storage location

The product must be stored in a covered and dry location free from heat, dirt, and vibrations.

NOTICE:

Protect the product against humidity, heat sources, and mechanical damage.

NOTICE:

Do not place heavy weights on the packed product.

3 Product Description

3.1 System description

System layout

The images show a typical single-pump and multi-pump system using the unit.

When the system is connected directly to the water supply use a low-pressure switch on the suction side.

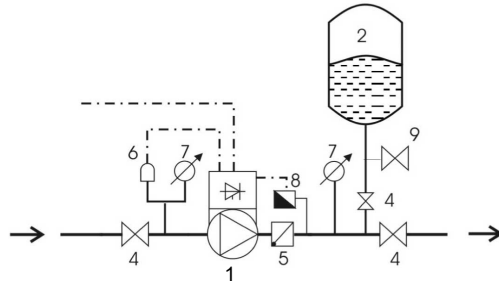

Figure 1: Single-pump system

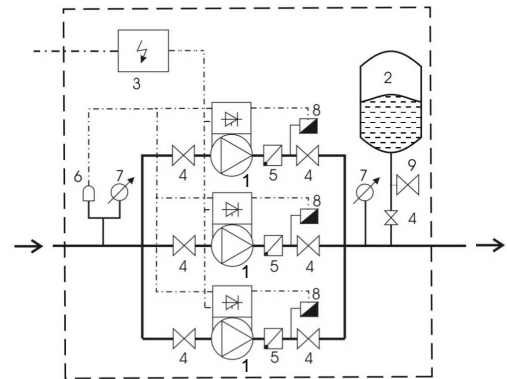

Figure 2: Multi-pump system

1. Pump with HYDROVAR
2. Diaphragm pressure tank
3. Distribution panel
4. Gate valve
5. Non-return valve
6. Low water control
7. Pressure gauge
8. Pressure sensor
9. Drain tap

Pressure tank

A diaphragm pressure tank is used on the discharge side of the pump to maintain pressure in the pipes when there is no water demand. The unit stops the pump from continuing to run at zero demand and reduce the size of the tank that is required for supply purposes.

The tank must be permitted and suitable for systems pressure.

The capacity of the tank must be 10% of the maximum system flow rate of the pump or pumps (0.1 times the flow rate in l/min or gal/min). Turn off the unit to reduce the water pressure to check and set the correct pre-charged pressure.

The pre-charge pressure of the tank can be determined by using the following table:

Required pressure or Start Value when active [bar]

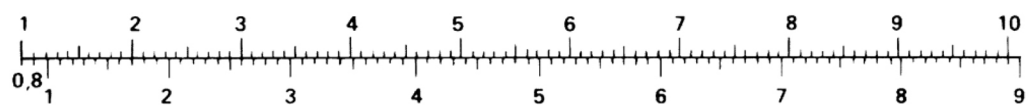

Pre-charge pressure [bar]

3.2 Product function and use

Description

HYDROVAR is a pump-mounted variable speed, microprocessor-based system controller. It can be mounted onto virtually any model of fan cooled motor and is simple to integrate into BMS systems with ModBus or Bacnet communication as standard.

In a variable speed controlled system, the pump works every time with the speed where it produces at the reduced flow exactly the required head. Therefore there is no wasted energy given to the system like on/off or bypass control.

Intended use

HYDROVAR is made for the following pump applications:

- Pressure, level, and flow regulation
- Closed loop systems
- Irrigation applications with single or multiple pumps

Improper use

The product must not be used for constant torque applications.

Approvals and certifications



The unit complies with UL508C thermal memory retention requirements.

3.3 Applications

Application alternatives

The application alternatives for the product are the following:

- Actuator
- Controller
- Cascade serial / Synchronous
- Cascade relay

3.3.1 Actuator

This mode is used for a unit in a single pump operation only. The unit operates as an actuator according an external speed signal or continuous operation on either one or two programmed frequencies. This is done by using the corresponding digital input.

3.3.2 Controller

This mode is set as the default operating mode and is used for a unit in a single pump operation.

3.3.3 Cascade serial / Synchronous

In these applications, each of the pumps (up to eight pumps) must be equipped with a unit.

The units are connected via the RS485 interface and communicate via the provided protocol.

The combination of the different units which are used in a multi-pump-system depends on the system requirements.

It is possible to run all pumps in cascade serial mode and synchronous mode as well. If one unit fails, then each pump of the system can become the lead pump and can take control.

3.3.4 Cascade relay

Description

One pump is fitted with the unit and up to five slave pumps can be switched to on/off on demand. The unit uses an additional Premium Card for this purpose. For switching the slave pumps an external switchboard has to be installed.

Example

The example shows a booster set with four pumps where only one speed-controlled pump and the others are fixed speed.

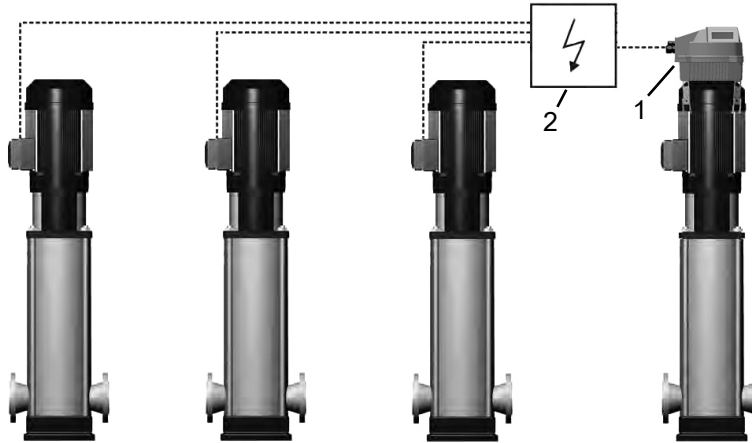

- 1. HYDROVAR
- 2. External panel

3.4 The data plate

Type definition code

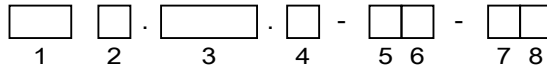

Figure 3: Definition code and placement

No.	Description	Alternatives
1	Brand	HVL - HYDROVAR
2	Power supply	2: 1~ 230 VAC 3: 3~ 230 VAC 4: 3~ 380-460 VAC
3	Shaft power *10 [kW]	015: 1.5 kW (2.0 HP) 022: 2.2 kW (3.0 HP) 030: 3.0 kW (4.0 HP) 040: 4.0 kW (5.0 HP) 055: 5.5 kW (7.5 HP) 075: 7.5 kW (10.0 HP) 110: 11.0 kW (15.0 HP) 150: 15.0 kW (20.0 HP) 185: 18.5 kW (25.0 HP) 220: 22.0 kW (30.0 HP)
4	Enclosure rate	A: IP 55 / Type1
5	Bus communication	0: Standard communication

No.	Description	Alternatives
6	Optional cards	0: No optional cards
7	Internal display	1: Standard internal display installed
8	Other options	0: No other options installed

Example

HVL 4 . 075 . A - 00 - 10
 1 2 3 4 5 6 7 8

No.	Example	Description
1	HVL	HYDROVAR
2	4	Power Supply: 3~ 380-460 VAC
3	075	Shaft power: 7.5 kW (10.0 HP)
4	A	Enclosure rate: IP 55 / Type1
5	0	Standard communication
6	0	No optional cards installed
7	1	Standard internal display installed
8	0	No other options installed

3.5 Technical Data

Electrical specification

HVL																					
	2.015	2.022	2.030	2.040	3.015	3.022	3.030	3.040	3.055	3.075	3.110	4.015	4.022	4.030	4.040	4.055	4.075	4.110	4.150	4.185	4.220
Input																					
Mains Supply	L N				L1 L2 L3							L1 L2 L3									
Nominal input voltage (Vin):	208-240±10%				208-240±10%							380-460±15%									
Maximum Input Current, continuous [A]:	11.6	15.1	22.3	27.6	7.0	9.1	13.3	16.5	23.5	29.6	43.9	3.9	5.3	7.2	10.1	12.8	16.9	24.2	33.3	38.1	44.7
efficiency, rated [%], typically:	94.0	93.5	93.5	93.5	96.0	96.0	96.0	96.0	96.0	96.0	96.0	96.0	96.5	96.5	96.5	97.0	97.0	97.0	97.0	97.0	97.0
Output																					
Output voltage (V)	0-240				0-100% of supply voltage							0-100% of supply voltage									
Maximum output current, continuous [A]:	7.5	10	14.3	16.7	7.5	10	14.3	16.7	24.2	31	44	4.1	5.7	7.3	10	13.5	17	24	32	38	44
Output frequency (Hz)	15-70																				

Environmental specification

Storage temperature	-30°C [-22°F] to 70°C [158°F]
Relative humidity	5%-95% - Condensation is not permitted
Operational temperature	-10°C [-14°F] to 55°C [131°F] 100% power rating -10°C [-14°F] to 40°C [104°F] with de-rating 40°C [104°F] to 55°C [131°F]

Air pollution	The air may contain dry dust as found in workshops where there is excessive dust due to machines. Excessive amounts of dust, acids, corrosive gases, salts etc are not permitted.
Altitude	Max. 1000 m above sea level. For installation over 1000 m above sea level, the maximum output power has to be de-rated by 1% for every additional 100 m. If the installation site is over 2000 m above sea level, please contact your local distributor or service contact.

Installation specification

Protection	Motor drive input have to be protected by an external circuit breaker/ fuse
Motor wire type	shielded power cable
Maximum motor cable length (no EMC compliant), screened	50m (164ft)
Maximum motor cable length (no EMC compliant), unscreened	100m (328ft)

EMC compliance

In accordance with IEC 61800-3 and EN 61000 series standards, shield cable will be used for motor drive output and communication.

Installations must be done according EMC correct installations and avoiding pigtailed (on the drive side), otherwise EMC cannot be guaranteed.

Class of protection

- IP55, Enclosure Type 1
- Protect the product from direct sunlight
- Protect the product from direct rainfall
- Outdoor installation without protection, to especially keep the temperature limits of the product, is not permitted

3.6 Motor thermal protection

Motor thermal protection can be implemented using various techniques: PTC sensor in motor windings or Software Thermal Control (STC).

Protection against motor overheating comes from par. 290 "STC Motor Protection", which by default is pre-set to data value "STC trip".

NOTICE: The STC function is initialized at $1.125 \times$ rated motor current and rated motor frequency. The STC function provides class 20 motor overload protection in accordance with the NEC.

Motor thermal protection prevents the motor from overheating. The STC function is an electronic feature that simulates a bimetal relay that is based on internal measurements. The characteristic is shown in the following figure.

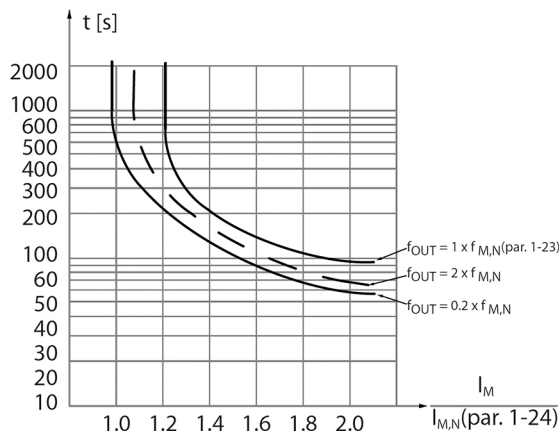

The X-axis shows the ratio between $I_{\text{motor actual}}$ and $I_{\text{motor nominal}}$. The Y-axis shows the time in seconds before the STC cuts off and trips the frequency converter. The curves show the characteristic nominal speed, at twice the nominal speed and at 20% of the nominal speed. The curve shows that at lower speed the STC cuts off at lower heat due to less cooling of the motor. In that way, the motor is protected from overheating even at low speed. The STC function calculates the motor temperature that is based on actual current and speed.

The calculated percentage of allowed maximum temperature is visible as a readout in par. 293 "Motor Thermal".

With the STC the motor is protected from being overheated and there is no need for any further motor protection. That means when the motor is heated up the STC timer controls how long the motor can be operated at the high temperature before it is stopped in order to prevent overheating.

Motor thermal protection can also be achieved using an external thermistor: set par. 290 "STC Motor Protection" to data value "Thermistor trip".

3.7 Dimensions and weights

Reading instructions

All measurements are in millimeters (inches).

The images are not to scale.

Free distance

Area	Models	Free distance
Above the unit	All	> 300 mm (12 in)
Center-distance between units (to ensure space for cabling):	HVL 2.015 ÷ 2.022 3.015 ÷ 3.022 4.015 ÷ 4.040	> 300 mm (12 in)
	HVL 2.030 ÷ 2.040 3.030 ÷ 3.055 4.055 ÷ 4.110	> 430 mm (17 in)
	HVL 3.075 ÷ 3.110 4.150 ÷ 4.220	> 550 mm (21,6 in)

Dimensional drawings

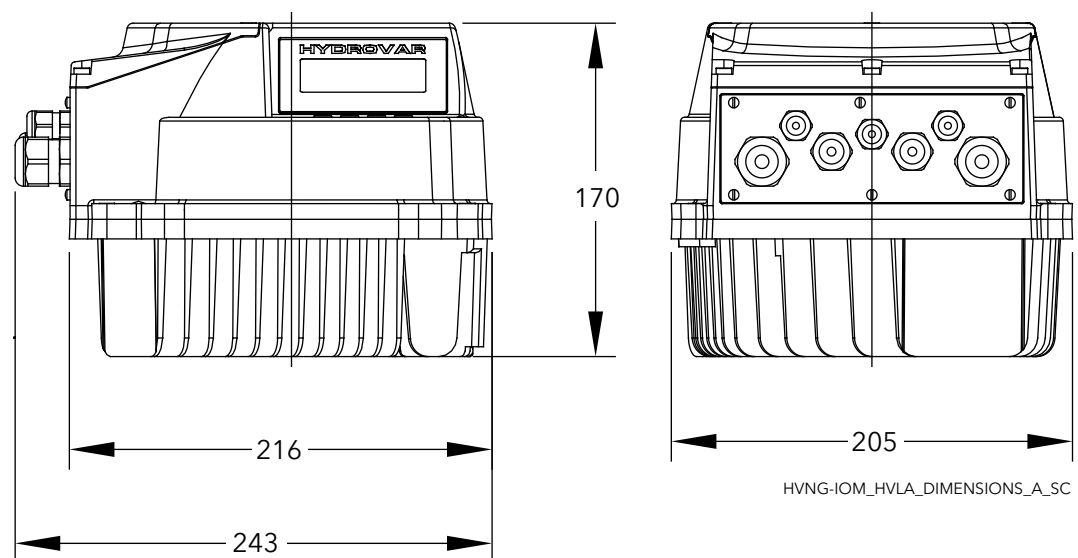

Figure 4: HVL2.015, HVL2.022, HVL3.015, HVL3.022, HVL4.015 ÷ HVL4.040

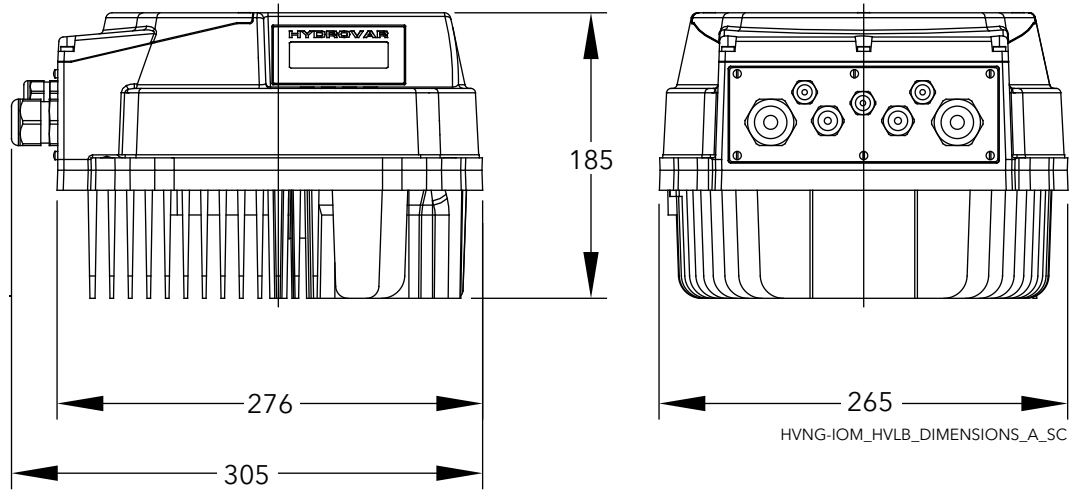

Figure 5: HVL2.030, HVL2.040, HVL3.030 ÷ HVL3.055, HVL4.055 ÷ HVL4.110

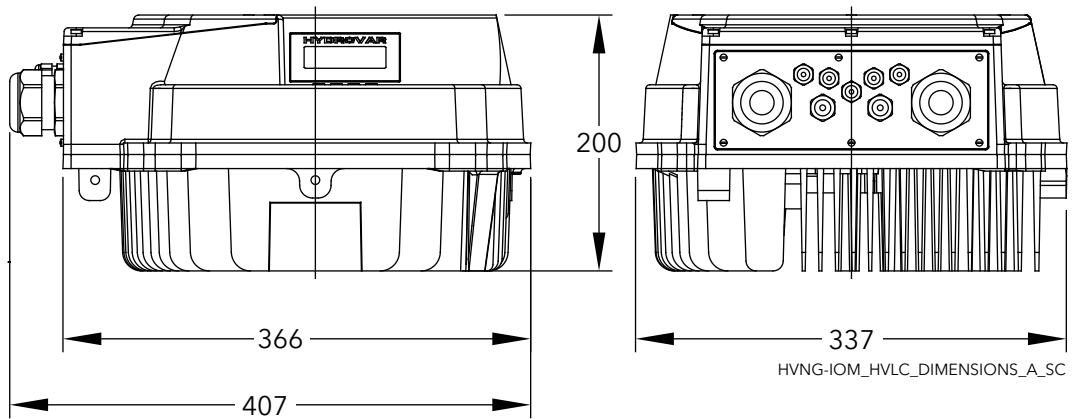

Figure 6: HVL3.075 ÷ HVL3.110, HVL4.150 ÷ HVL4.220

Weight

Models	Maximum Weight
HVL 2.015 ÷ 2.022 3.015 ÷ 3.022 4.015 ÷ 4.040	5,6 Kg (12,3 lbs)
HVL 2.030 ÷ 2.040 3.030 ÷ 3.055 4.055 ÷ 4.110	10,5 Kg (23 lbs)
HVL 3.075 ÷ 3.110 4.150 ÷ 4.220	15,6 Kg (34,4 lbs)

3.8 Design and layout

Parts and descriptions

The unit can be fitted with the features the application requires.

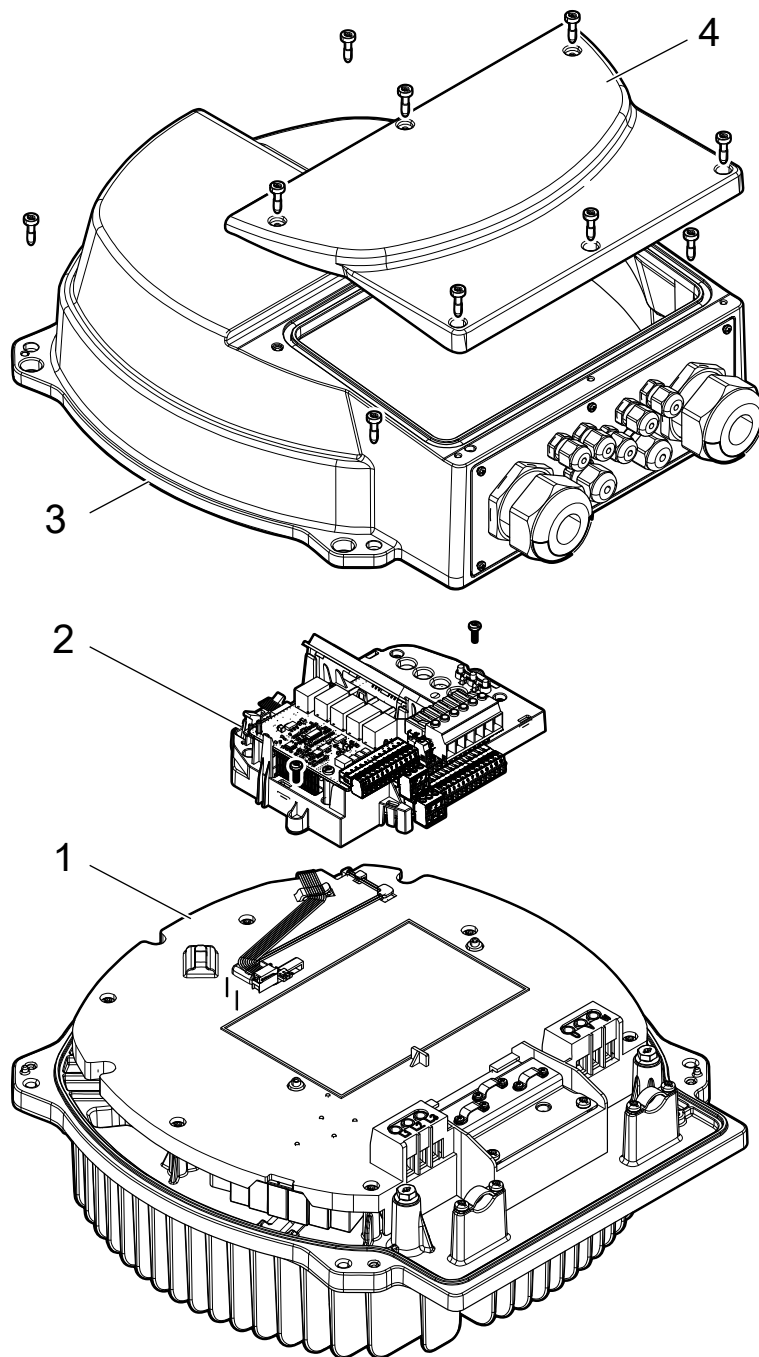

Position number	Description
1	Power board, heatsink, EMC filter
2	Control board
3	Cover
4	Plastic cover

3.9 Included mounting components

Included components		Cable outer diameter		Model		
		(mm)	inches	HVL 2.015 ÷ 2.022 3.015 ÷ 3.022 4.015 ÷ 4.040	HVL 2.030 ÷ 2.040 3.030 ÷ 3.055 4.055 ÷ 4.110	HVL 3.075 ÷ 3.110 4.150 ÷ 4.220
Cable Gland(s) and Lock Nut(s)	M12	3.5 ÷ 7.0	0.138 ÷ 0.275	3	3	3
	M16	5.0 ÷ 10.0	0.197 ÷ 0.394	2	2	2
	M20	7.0 ÷ 13.0	0.275 ÷ 0.512	2		
	M25	10.0 ÷ 17.0	0.394 ÷ 0.669		2	
	M32	13.0 ÷ 21.0	0.512 ÷ 0.827			2
	M40	19.0 ÷ 28.0	0.748 ÷ 1.102			2
Entry Thread Reducer	M40 -> M32					2
Plug(s) for Cable Gland(s)	M12			3	3	3
	M16			2	2	2
Screws	M5x30			4		
	M5x40			4		
	M6x40				4	4
	M6x50				4	4
Spade Connector(s) for PE conductors	RF-U 4			2	2	
	BF-U 4			2	2	
	GF-U 4			2	2	
Spares sealing ring					2	
Centering pin				1	1	1
Mounting Clamps				4	4	4

For HVL 3.075 ÷ 3.110 or HVL 4.150 ÷ 4.220, if the cables outer diameter is incompatible with the included cable glands, use the supplied Entry Thread Reducers (and spares sealing rings).

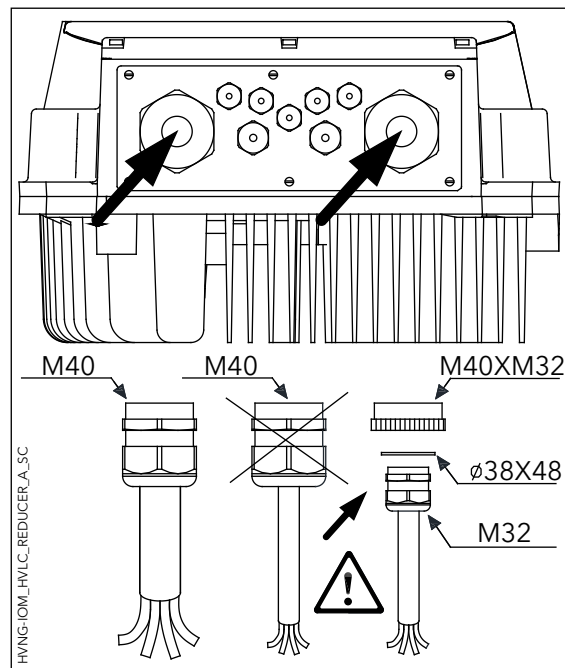

3.10 Optional components

Components

Component	Description
Motor cables	The motor cable that is ready to connect to the unit.
Mounting ring	If the motor fan is made of plastic, then a mounting ring is used. It is available in two diameters: 140 mm (5.5 in) and 155 mm (6.1 in).
Sensors	The following sensors can be used with the unit: <ul style="list-style-type: none"> • Pressure-transducer • Differential pressure-transducer • Temperature-sensor • Flow indicator (orifice plate, inductive flow meter) • Level-sensor
Premium Card HYDROVAR	Card to control up to five slave pumps and to connect additional analog and digital I/Os
Wi-Fi Card HYDROVAR	To connect and interact wireless with HYDROVAR

4 Installation

4.1 Installation site checklist



DANGER:

Never install the system controller in an explosive or flammable environment.



WARNING:

- Always refer to the local and national regulations, legislation, and codes in force regarding selection of installation site, and water and power connections.
 - Keep the manual, drawings, and diagrams accessible for detailed installation and operation instructions. It is important that the manual is available for equipment operators.
 - Install the unit on the motor fan cover. Keep motor cables as short as possible. Check the motor characteristics for actual tolerances.
 - For wall mounting installations with long motor cables, use the output filter option to protect the motor.
 - Ensure that the ingress protection rating of Hydrovar (IP55, Type1) is suitable for the installation environment.
-



CAUTION:

- Ingress protection. IP55 (Type 1) rating can only be guaranteed if the unit is properly closed.
 - Make sure that there is no liquid on the unit before opening the plastic cover.
 - Ensure all cable glands and unused holes for glands are properly sealed.
 - Ensure that the plastic cover is properly closed.
 - Device damage through contamination. Do not leave Hydrovar uncovered.
-

4.2 Frequency converter and motor pre-installation check list

- Compare the model number of the unit on the nameplate to what was ordered to verify the proper equipment.
- Ensure each of the following are rated for same voltage:
 - Mains (power)
 - Frequency converter
 - Motor
- Ensure that the frequency converter output current rating is equal to or greater than motor service factor current for peak motor performance.
 - Motor size and frequency converter power must match for proper overload protection.
 - If frequency converter rating is less than motor, full motor output cannot be achieved.

5 Mechanical Installation

5.1 Cooling

- The frequency converter is cooled by means of air circulation. To protect the unit from overheating, it must be ensured that the ambient temperature does not exceed the maximum temperature stated for the frequency converter and that the 24-hour average temperature is not exceeded.
- Derating for temperatures between 40°C (104°F) and 50°C (122°F) and elevation 1000 m (3300 ft) above sea level must be considered.
- Improper mounting can result in overheating and reduced performance.



CAUTION:

During the normal operation, the heat sink surfaces may be so hot that only the buttons should be touched to avoid burns.

5.2 Lifting

- Check the weight of the unit to determine a safe lifting method.
- Ensure that the lifting device is suitable for the task.
- If necessary, plan for a hoist, crane, or forklift with the appropriate rating to move the unit.
- For lifting, use hoist rings on the unit, when provided.

5.3 Mounting

- Install the unit on the motor fan cover. Keep motor cables as short as possible. Check the motor characteristics for actual tolerances.

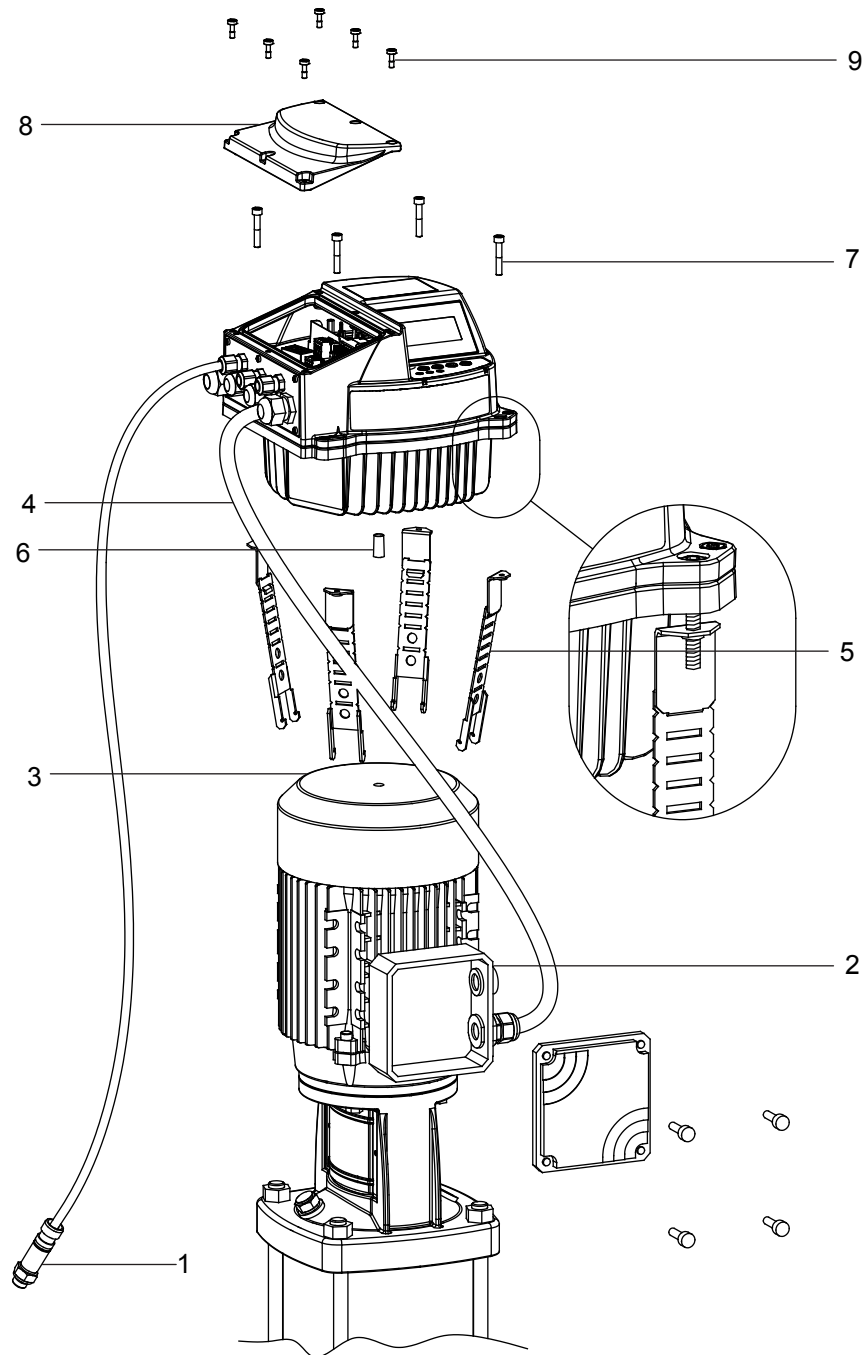

HVNG-IOM_MOUNT_EXPLOD-1_B_SC

1. Actual value sensor
2. Motor conduit box
3. Motor fan cover
4. Motor cable
5. Mounting clamps
6. Centring pin
7. Screws for mounting clamps
8. Plastic cover
9. Screws for plastic cover

Refer to callouts in preceding image.

1. Fit the rubber centering pin [6] on the bottom of the HYDROVAR®.

NOTICE:

Always use a stainless steel mounting ring if the motor's fan cover is made of plastic.

2. Center the unit on the motor fan cover [3] using the centering pin [6].
3. Adjust mounting clamps [5] length for smaller motor sizes, as indicated in the picture that follows.

NOTICE:

Take care about sharp edges and remove them properly.

4. Fasten the unit:
 - a. Fasten the mounting clamps [5] and relative screws [7].
 - b. Tighten the screws [7] until the two bottom teeth in the brackets grip the fan cover.
 - c. Tighten the screws until the unit is securely fastened.
5. Remove the screws for plastic cover [9].
6. Remove the plastic cover [8].
7. Make the electrical connections.
 - For more information about how to make the electrical connections, see [Electrical Installation](#).

NOTICE:

You can remove the metal plate to make the electrical installation easier.

8. Mount and fasten the plastic cover [8] using 2,0 Nm tightening torque.

**Electrical Hazard:**

Make sure that all the cable glands are mounted properly and that all the unused cable entries use closing plugs.

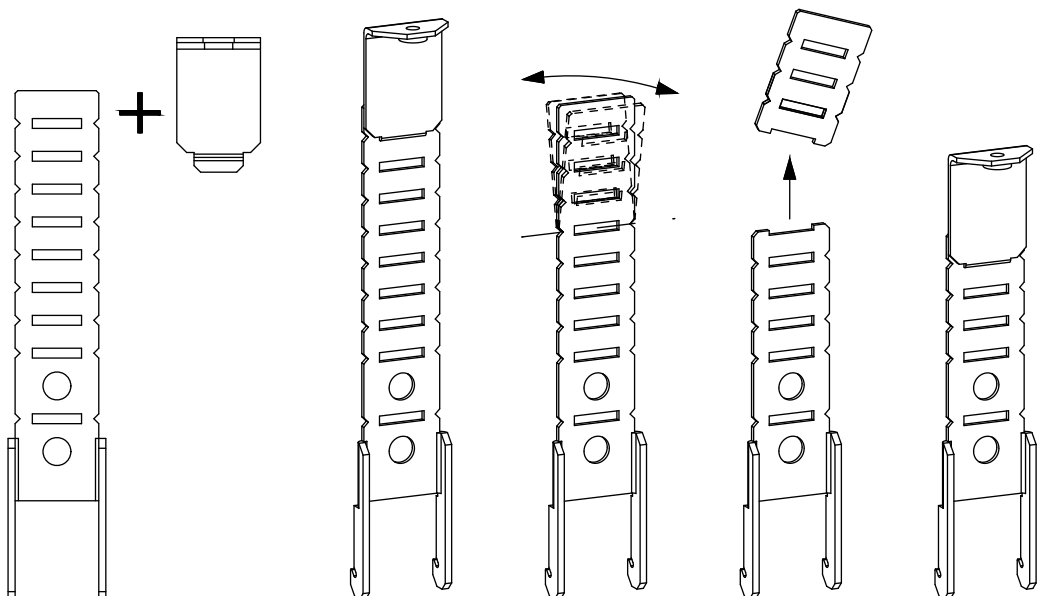
Mounting clamps

6 Electrical Installation

6.1 Precautions



WARNING:

- **EQUIPMENT HAZARD.** Rotating shafts and electrical equipment can be hazardous. All electrical work must conform to national and local electrical codes. Installation, start-up, and maintenance must be performed by trained and qualified personnel. Failure to follow these guidelines could result in death or serious injury.
-



Electrical Hazard:

- All electrical wiring must be carried out by an authorized electrician, in accordance with the electrical regulations locally in force.
-

NOTICE:

WIRING ISOLATION. Run input power, motor wiring and control wiring in three separate metallic conduits or use separated shielded cable for high frequency noise isolation. Failure to isolate power, motor and control wiring could result in less than optimum frequency converter and associated equipment performance.

For your safety comply with the following requirement:

- Electronic control equipment is connected to hazardous mains voltage. Extreme care should be taken to protect against electrical hazards when applying power to the unit.

Earth (grounding) requirements



WARNING:

For operator safety, it is important to ground the frequency converter properly in accordance with national and local electrical codes as well as instructions contained within this document. Ground currents are higher than 3.5 mA. Failure to ground the frequency converter properly could result in death or serious injury.

NOTICE:

It is the responsibility of the user or certified electrical installer to ensure correct grounding (earthing) of the equipment in accordance with national and local electrical codes and standards.

- Follow all local and national electrical codes to ground electrical equipment properly.
- Proper protective grounding for equipment with ground currents higher the 3.5 mA must be established. See the Leakage current (>3.5 mA) section for details.
- A dedicated ground wire is required for input power, motor power and control wiring.
- Use the clamps provided with the equipment for proper ground connections.
- Do not ground one frequency converter to another in a "daisy chain" fashion.
- Keep the ground wire connections as short as possible.
- Using high-strand wire to reduce electrical noise is recommended.
- Follow motor manufacturer wiring requirements.

Leakage current (>3.5 mA)

Follow national and local codes regarding protective earthing of equipment with a leakage current > 3.5 mA. Frequency converter technology implies high frequency switching at high power. This will generate a leakage current in the earth connection. A fault current in the frequency converter at the output power terminals might contain a DC component which can charge the filter capacitors and cause a transient earth current. The

earth leakage current depends on various system configurations including RFI filtering, screened motor cables, and frequency converter power.

EN/EC61800-5-1 (Power Drive System Product standard) requires special care if the leakage current exceeds 3.5 mA. Earth grounding must be reinforced in one of the following ways:

- Earth ground wire of at least 8 AWG or 10 mm² Cu (or 16mm² Al).
- Two separate earth ground wires of the same cross sectional area.

See EN60364-5-54 section 543.7 for further information.

On HYDROVAR, the phase conductor and the corresponding protective earthing conductor can be of the same cross-sectional area, provided they are made of the same metal (because the cross-sectional area of the phase conductor is less than 16 mm²).

The cross-sectional area of every protective earthing conductor which does not form a part of the supply cable or cable enclosure shall, in any case, be not less than:

- 2.5 mm² if mechanical protection is provided or
- 4 mm² if mechanical protection is not provided. For cord-connected equipment, provisions shall be made so that the protective earthing conductor in the cord shall, in the case of failure of the strain-relief mechanism, be the last conductor to be interrupted.

6.2 Protection devices

Fuses and Circuit Breakers

- An electronically activated function within the frequency converter provides overload protection in the motor. The overload calculates the level of increase to activate timing for the trip (controller output stop) function. The higher the current draw, the quicker the trip response. The overload provides Class 20 motor protection. See Warnings and alarms for details on the trip function.
- Hydrovar must be provided with short-circuit and over-current protection to avoid overheating of the cables in the installation. Input fusing and/or circuit breakers are required to provide this protection. Fuses and Circuit Breakers must be provided by the installer as part of installations.
- Use recommended fuses and/or circuit breakers on the supply side as protection in case of component breakdown inside the adjustable frequency drive (first fault). Use of recommended fuses and circuit breakers ensures possible damage to the adjustable frequency drive is limited to damages inside the unit. For other circuit breaker types, ensure that the energy into the adjustable frequency drive is equal to or lower than the energy provided by recommended types.
- The fuses below are suitable for use on a circuit capable of delivering 100,000 Ams (symmetrical), 480V maximum. With the proper fusing the adjustable frequency drive Short Circuit Current Rating (SCCR) is 100,000 Ams.

Table 1: Recommended fuses and circuit breakers

Voltage supply	HVL	Fuse				Circuit breaker	
		UL				Non UL	
		Bussmann	Edison	Littelfuse	Ferraz-Shawmut	Fuse	ABB
		Type T				Type gG	MCB S200
1~ 230 VAC	2.015	JJN-20	TJN (20)	JLLN 20	A3T20	20	S201-C20
	2.022	JJN-25	TJN (25)	JLLN 25	A3T25	25	S201-C25
	2.030	JJN-35	TJN (35)	JLLN 35	A3T35	35	S201-C32
	2.040	JJN-35	TJN (35)	JLLN 35	A3T35	35	S201-C40

Voltage supply	HVL	Fuse					Circuit breaker
		UL				Non UL	
		Bussmann	Edison	Littelfuse	Ferraz-Shawmut	Fuse	ABB
		Type T				Type gG	MCB S200
3~ 230 VAC	3.015	JJN-15	TJN (15)	JLLN 15	A3T15	16	S203-C16
	3.022	JJN-15	TJN (15)	JLLN 15	A3T15	16	S203-C16
	3.030	JJN-20	TJN (20)	JLLN 20	A3T20	16	S203-C20
	3.040	JJN-25	TJN (25)	JLLN 25	A3T25	25	S203-C25
	3.055	JJN-30	TJN (30)	JLLN 30	A3T30	25	S203-C32
	3.075	JJN-50	TKN (50)	JLLN 50	A3T50	50	S203-C50
	3.110	JJN-60	TJN (60)	JLLN 60	A3T60	63	S203-C63
3~ 380-460 VAC	4.015	JJS-10	TJS (10)	JLLS 10	A6T10	10	S203-C10
	4.022	JJS-10	TJS (10)	JLLS 10	A6T10	10	S203-C13
	4.030	JJS-15	TJS (15)	JLLS 15	A6T15	16	S203-C13
	4.040	JJS-15	TJS (15)	JLLS 15	A6T15	16	S203-C16
	4.055	JJS-20	TJS (20)	JLLS 20	A6T20	20	S203-C20
	4.075	JJS-20	TJS (20)	JLLS 20	A6T20	20	S203-C25
	4.110	JJS-30	TJS (30)	JLLS 30	A6T30	30	S203-C32
	4.150	JJS-50	TJS (50)	JLLS 50	A6T50	50	S203-C50
	4.185	JJS-50	TJS (50)	JLLS 50	A6T50	50	S203-C50
	4.220	JJS-60	TJS (60)	JLLS 60	A6T60	63	S203-C63

Type gG fuses in the table are reporting the fuses rated current.

Residual Current Devices, RCDs (GFCIs)

Where Ground Fault Circuit Interrupters (GFCIs) and residual current devices (RCDs), also know as earth leakage circuit breakers (ELCDs), are used, comply with the following:

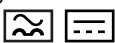
- for HVL 2.015 ÷ 2.040, use GFCIs (RCDs) which are capable of detecting AC currents and pulsating currents with DC components. These GFCIs (RCDs) are marked with the following symbol: 
- for HVL 3.015 ÷ 3.110 and 4.015 ÷ 4.220, use GFCIs (RCDs) which are capable of detecting AC and DC currents. These GFCIs (RCDs) are marked with the following symbols: 
- Use GFCIs (RCDs) with an inrush delay to prevent faults due to transient earth currents.
- Dimension GFCIs (RCDs) according to the system configuration and environmental considerations.

NOTICE:

When an earth leakage circuit breaker or ground fault circuit interrupter is selected, the total leakage current of all the electrical equipment in the installation must be taken into account.

6.3 Wire type and ratings

- All wiring must comply with local and national regulations regarding cross section and ambient temperature requirements.
- Use cables with a minimum heat resistance of +70 °C (158 °F); to obey the UL (Underwriters Laboratories) regulations, it is recommended that all power connections be made with a minimum 75°C rated copper wire of the following types: THW, THWN.

Table 2: Recommended power connections cables

HVL	Power supply input cable + PE		Motor output cables + PE	
	Wire numbers x Max. copper section	Wire numbers x Max. AWG	Wire numbers x Max. copper section	Wire numbers x Max. AWG
2.015	3 x 2mm ²	3 x 14AWG	4 x 2mm ²	4 x 14AWG
2.022				
2.030	3 x 6mm ²	3 x 10AWG	4 x 6mm ²	4 x 10AWG
2.040				
3.015	4 x 2mm ²	4 x 14AWG	4 x 2mm ²	4 x 14AWG
3.022				
3.030	4 x 6mm ²	4 x 10AWG	4 x 6mm ²	4 x 10AWG
3.040				
3.055	4 x 16mm ²	4 x 5AWG	4 x 16mm ²	4 x 5AWG
3.075				
3.110	4 x 2mm ²	4 x 14AWG	4 x 2mm ²	4 x 14AWG
4.015				
4.022	4 x 6mm ²	4 x 10AWG	4 x 6mm ²	4 x 10AWG
4.030				
4.040	4 x 16mm ²	4 x 5AWG	4 x 16mm ²	4 x 5AWG
4.055				
4.075	4 x 2mm ²	4 x 14AWG	4 x 2mm ²	4 x 14AWG
4.110				
4.150	4 x 6mm ²	4 x 10AWG	4 x 6mm ²	4 x 10AWG
4.185				
4.220	4 x 16mm ²	4 x 5AWG	4 x 16mm ²	4 x 5AWG

Table 3: Tightening torques for power connections

HVL	Tightening torque			
	Mains and motor cable terminals		Earth conductor	
	Nm	lb-in	Nm	lb-in
2.015 ÷ 2.022 3.015 ÷ 3.022 4.015 ÷ 4.040	0.8	7.1	3	26.6
2.030 ÷ 2.040 3.030 ÷ 3.055 4.055 ÷ 4.110	1.2	10.6	3	26.6
3.075 ÷ 3.110 4.150 ÷ 4.220	1.2	10.6	3	26.6

Control cables

All control cables that are connected to the control board must be screened.
External volt free contacts must be suitable for switching < 10 VDC.

NOTICE:

If unscreened control cables are used, then signal interference with the incoming signals and the function of the unit can be compromised.

Table 4: Recommended control cables

Hydrovar Control Cables	Copper section		Tightening torque	
	mm ²	AWG	Nm	lb-in.
All I/O conductors	0.2 ÷ 1.6	25 ÷ 16	0.5-0.6	4.5-5.4

6.4 EMC compatibility

6.4.1 EMC requirements

Hydrovar fulfills the product standard EN61800-3:2004 + A1:2012, which defines categories (C1 to C4) for device application areas.

Depending on the motor cable length, a classification of Hydrovar by category (based on EN61800-3) is reported in the following table:

Table 5: EMC categories

HVL	Hydrovar classification by categories based on 61800-3
2.015 ÷ 2.040	C1 (*)
3.015 ÷ 3.110	C2 (*)
4.015 ÷ 4.220	C2 (*)

(*) 0,75 motor cable length; contact Xylem for further information

NOTICE: No external EMC filters are required to make Hydrovar compliant with the limit values of each category reported in the preceding table; motor cable shall be shielded.

6.4.2 Wiring the cables

To ensure electromagnetic compatibility the following points must be observed for cable installation:

- Ground cables should be as short as possible and with lowest impedance.
- Signal cables should be screened types to prevent disturbances from outside. Connect the shield to ground on one end only (to prevent ground loops), preferably to HYDROVAR GND using the pre mounted cable-clips; to connect a shield with lowest impedance to ground, remove the insulation from the signal cable and connect the shield to ground, as shown in the following image.
- Shielded Motor cable should be as short as possible; connect the shield to ground on both ends!

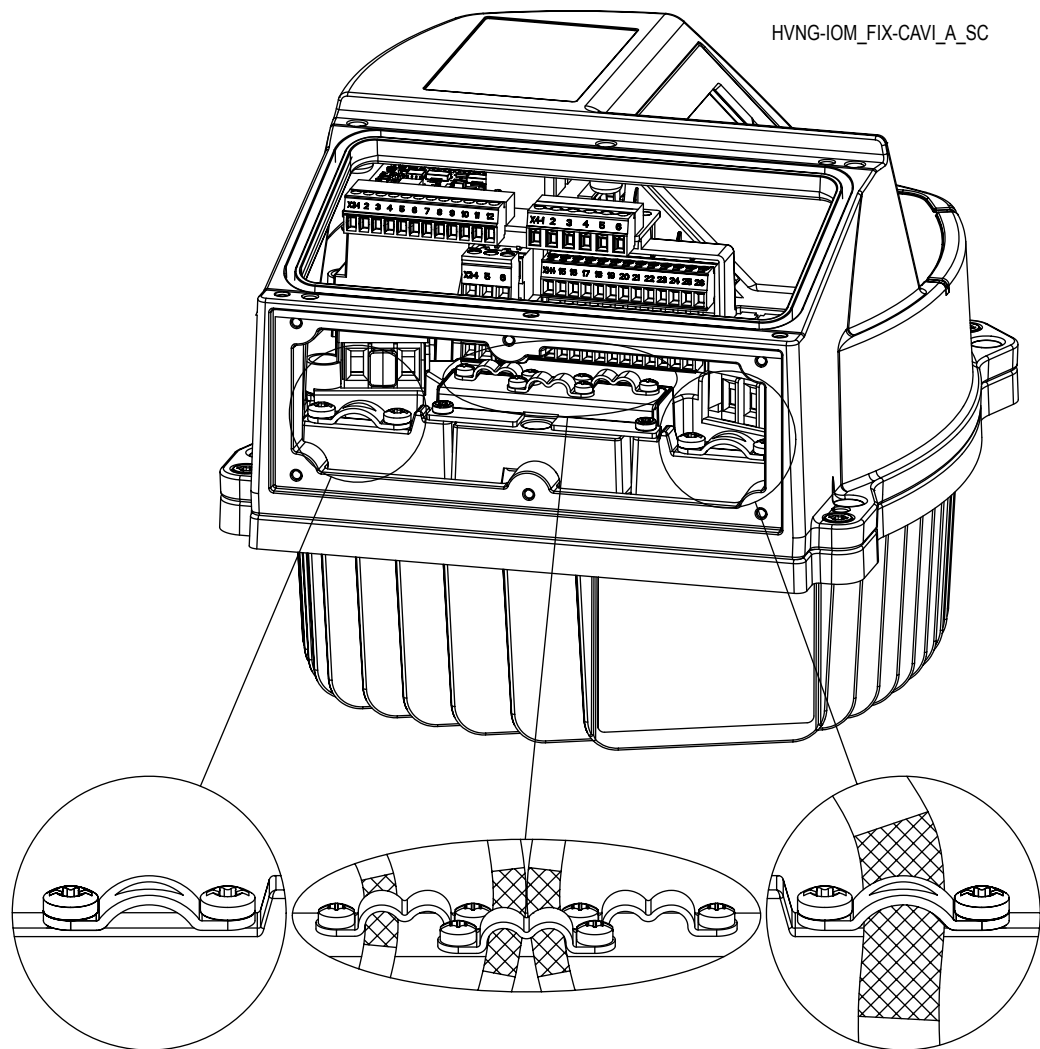
**NOTICE:**

Signal cables must be installed separate both from motor cable and power supply cable. If signal cables are installed in parallel to power supply cable or to motor cable for a longer distance, the distance between these cables should be more than 200mm. Do not cross power cables and control cables - if this is not possible, cross them only in an angle of 90°.

6.4.3 RFI switch

In case mains power supply is impedance-grounded (IT), the AC drive must have the EMC protection level C4 as per product standard EN61800-3:2004 + A1:2012: it is then necessary to deactivate the RFI filter of Hydrovar, by unscrewing the RFI switch depicted in the following image.

**WARNING:**

Do not make changes on Hydrovar when it is connected to mains: Make sure that the unit is disconnected from the power supply before removing the screw.

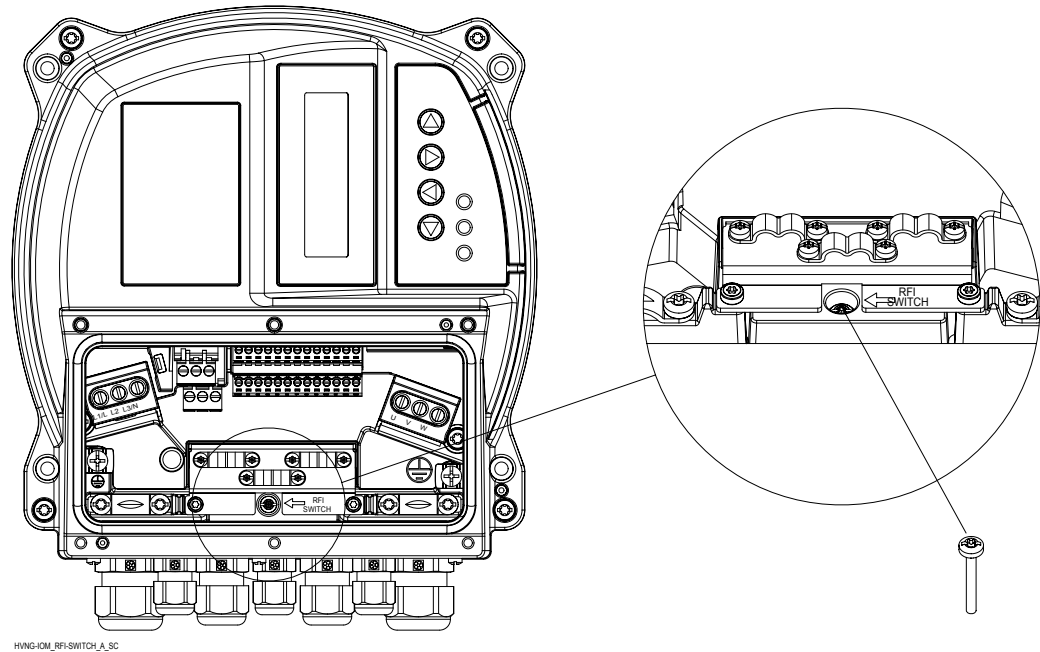

6.5 AC mains and motor connection terminals

Unscrew the dedicated 6 screws and remove the plastic cover of Hydrovar, in order to proceed wiring the power supply and the motor terminal, as described in the following paragraphs.

6.5.1 AC Mains (power supply) connection

1. Size wiring based upon the input current of Hydrovar
Comply with local and national electrical codes for cable sizes.
2. Connect 1-phase AC input power wiring to terminals L and N: make sure phase and neutral are properly aligned to provided terminals L and N.

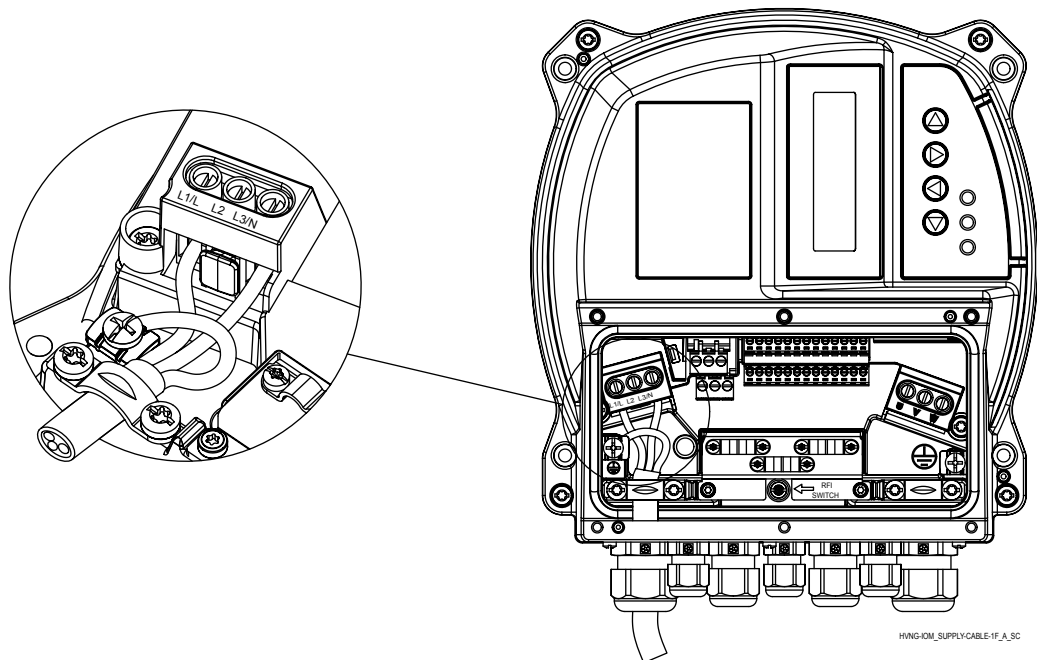

3. Connect 3-phase AC input power wiring to terminals L1, L2, and L3.

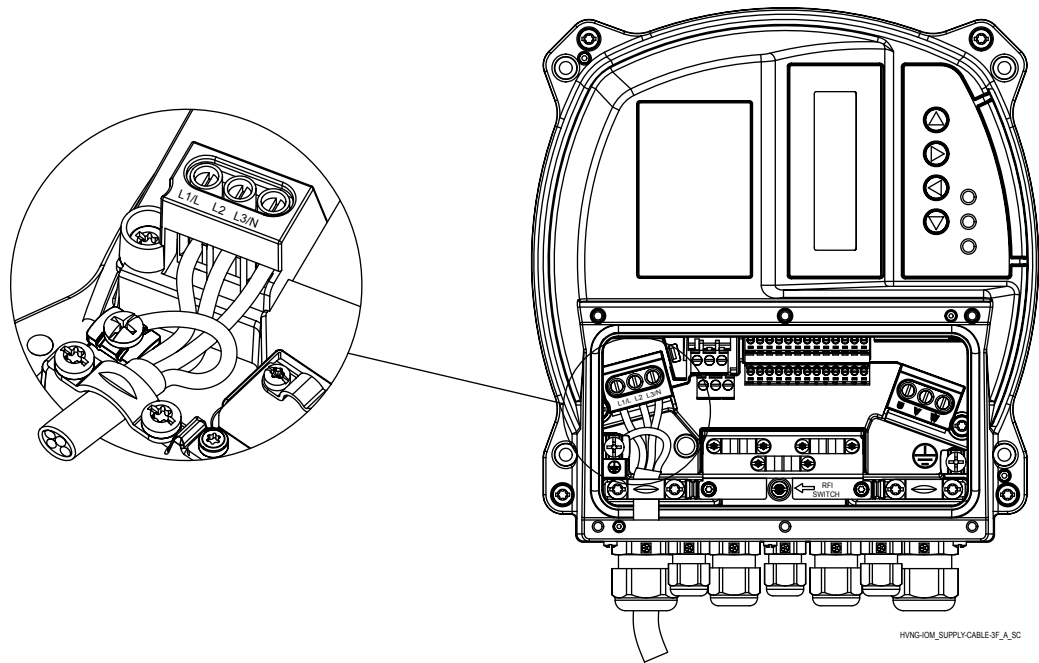

4. Ground the cable in accordance with grounding instructions provided.
5. If a double earthing is necessary, use the earth terminal under the heatsink of the drive.

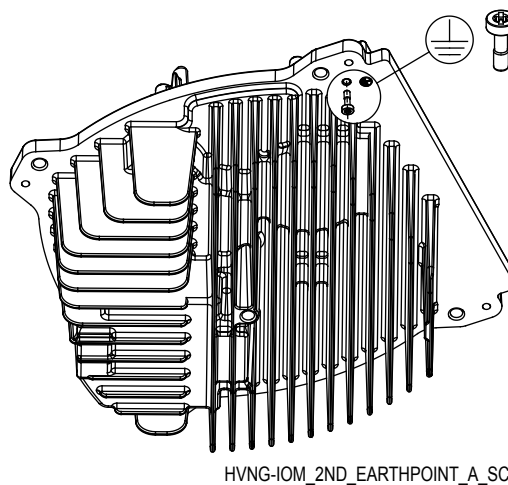

6.5.2 Motor connection



WARNING:

INDUCED VOLTAGE. Run output motor cables from multiple frequency converters separately. Induced voltage from output motor cables run together can charge equipment capacitors even with the equipment turned off and locked out. Failure to run output motor cables separately could result in death or serious injury.

- Comply with local and national electrical codes
- Do not install power factor correction capacitors between the frequency converter and the motor
- Do not wire a starting or pole-changing device between Hydrovar and the motor

- Connect 3-phase motor wiring to terminals U, V, and W.

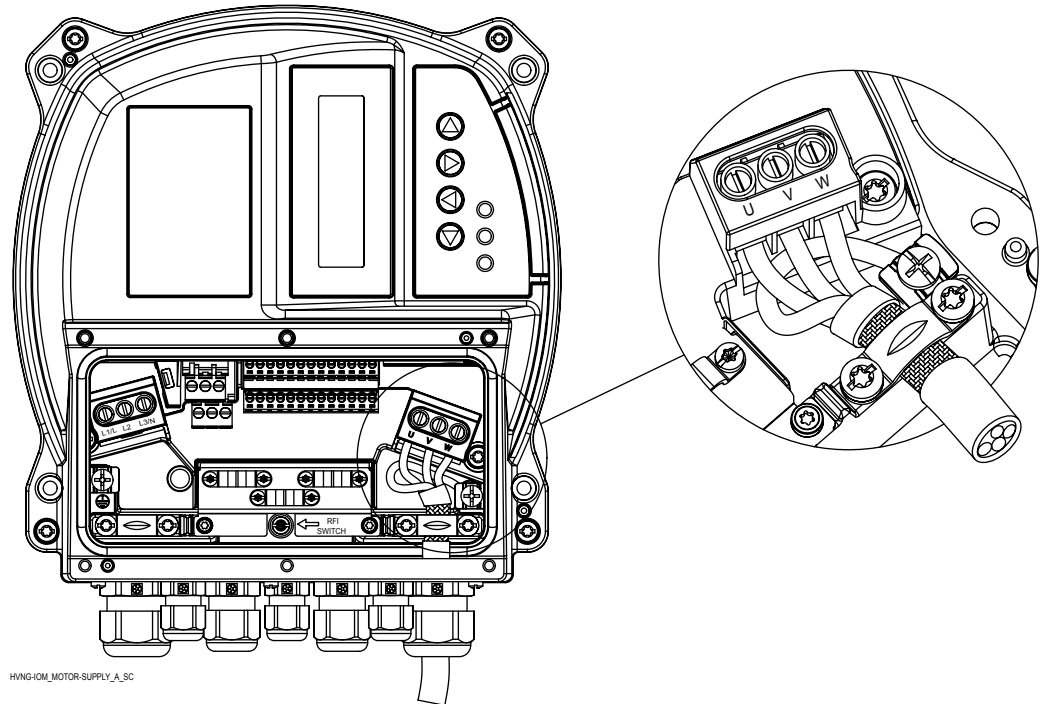

- Ground the cable in accordance with grounding instructions provided
- Torque terminals in accordance with the informations provided.
- Follow motor manufacturer wiring requirements
- The connection of the motor cable depends on the type of motor and can be done in star or delta connection: the right connection of the motor has to be selected as shown on the motor label according to the output voltage of the Hydrovar.
- The connection of the motor cable shield can be done using a pigtail connected to a PE screw (see image below), or by using a metallic cable gland in case of motor with metallic conduit box connected to PE.

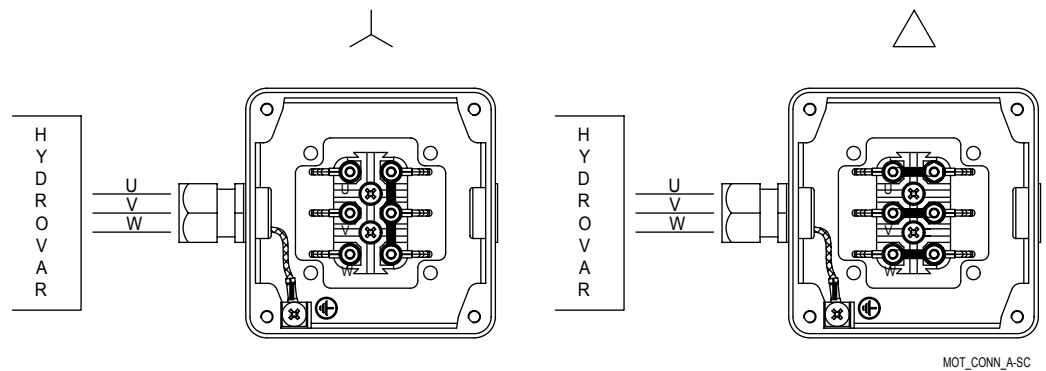

MOT_CONN_A-SC

6.6 Control terminals

Unscrew the dedicated 6 screws and remove the plastic cover of the Hydrovar, in order to proceed wiring the control terminals, as described in the following paragraphs; for reference, the wiring harness scheme is reported on the backside of the plastic cover too.

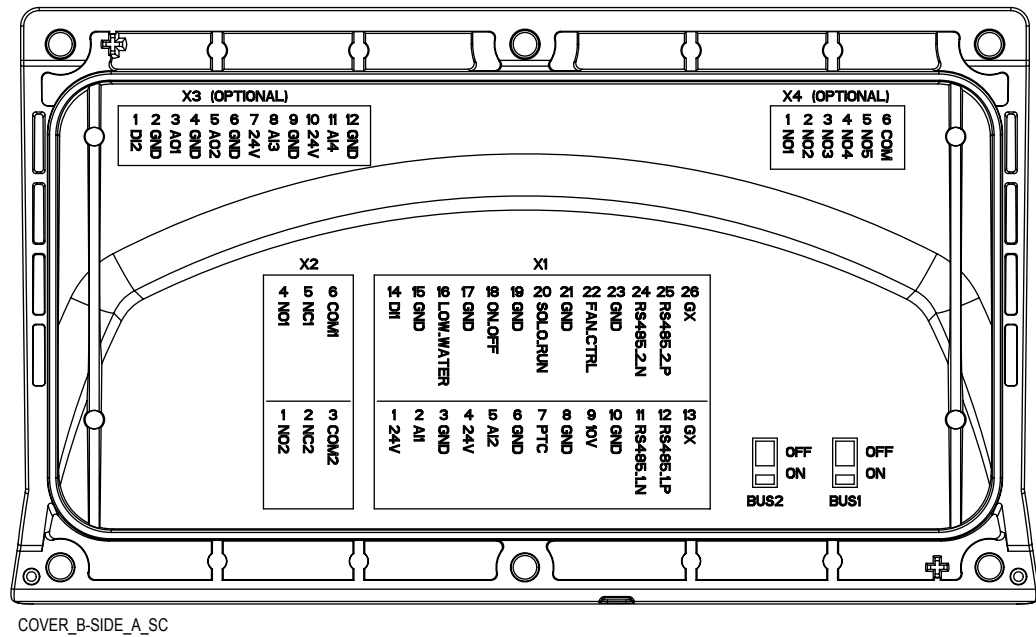

Figure 7: Cover

Do not connect the ground of the control card to other voltage potentials. All ground terminals and ground of the RS485 connection are connected internally.

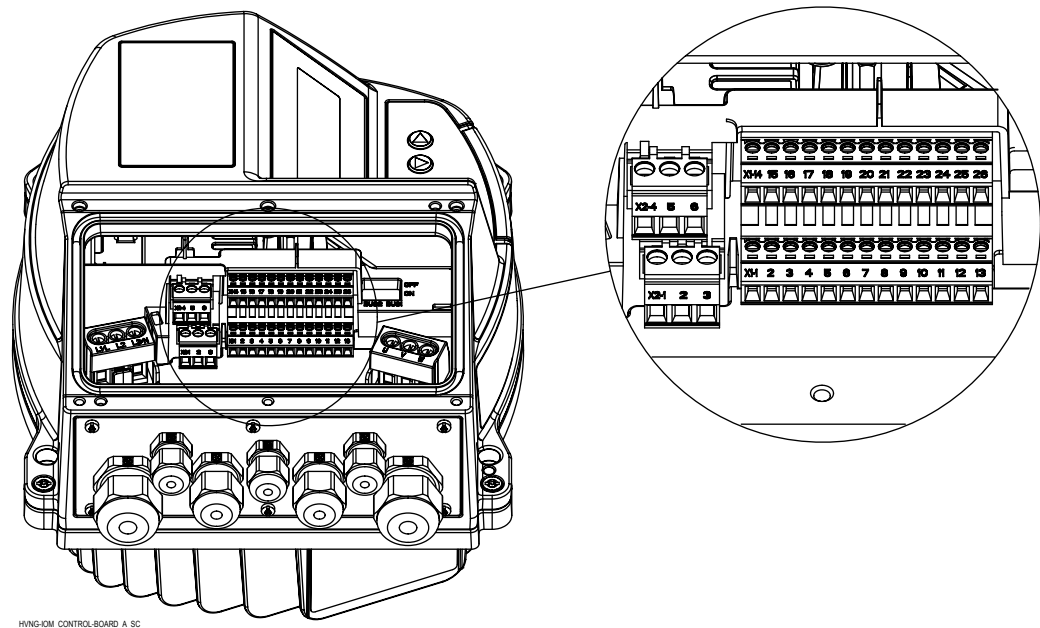

Figure 8: Control board

6.6.1 Motor sensor connection

Terminals X1/7 and X1/8 are used to connect a motor sensor (PTC or thermal switch) to stop the unit in case of failure; any other protective device can be connected to these terminals.

As described in par. 3.6 Motor thermal protection, this input can be enabled by setting par. 290 "STC Motor Protection" to data value "Thermistor trip".

Table 6: PTC terminals

Terminals	Description
X1/7	PTC or thermal switch input
X1/8	PTC or thermal switch input (Ground)

6.6.2 Input for emergency basic operations

Terminals X1/20 and X1/21 are used to connect an external switch which forces (when closed) Hydovar to perform a manual start-up till reaching the maximum frequency (fixed speed) set by par. 245 "Maximum Frequency

Table 7: SL terminals

Terminals	Description
X1/20	External switch (SOLO RUN) input
X1/21	External switch (SOLO RUN) input (Ground)

6.6.3 Digital and analog I/O

Several terminals, from X1/1 to X1/24, are used to connect analog and digital I/Os to correspondent input signals, most of them configurable by specific parameters.

Table 8: I/O terminals

Item	Terminals	Description	Comments
Sensor 1	X1/1	Power supply for external sensor 1	24VDC, Σ max. 100mA
	X1/2	Actual value current/voltage input sensor 1	0-20mA / 4-20mA / 0-10 VDC / 2-10 VDC
	X1/3	Ground for external sensor 1	GND, electronic ground (for X1/2)
Sensor 2	X1/4	Power supply for external sensor 2	24VDC, Σ max. 100mA
	X1/5	Actual value current/voltage input sensor 2	0-20mA / 4-20mA / 0-10 VDC / 2-10 VDC
	X1/6	Ground for external sensor 2	GND, electronic ground (for X1/5)
Auxiliary	X1/9	Auxiliary voltage supply	10VDC, max. 3mA
	X1/10	Ground for auxiliary voltage supply	GND, electronic ground (for X1/9)
Digital Input	X1/14	Configurable digital input 1	Active low
	X1/15	Ground for configurable digital input 1	GND, electronic ground (for X1/14)
Low water	X1/16	Low water input	Active low
	X1/17	Ground for low water input	GND, electronic ground (for X1/16)
External ON/OFF	X1/18	External ON/OFF input	Active low
	X1/19	Ground for external ON/OFF input	GND, electronic ground (for X1/18)
External fan (Not to be used: only for Wall Mounting kit connection!)	X1/22	External fan control	
	X1/23	Ground for external fan control	GND, electronic ground (for X1/22)

6.6.4 RS485 connection

Terminals X1/11, X1/12 and X1/13 are used for the communication among up to 8 Hydrovar in a multi-pump application; a dedicated termination resistor switch (BUS1, see image below) is made available to add a parallel terminator resistor to this RS485 port: if the resistor is needed put BUS1 switch on ON position.

Terminals X1/24, X1/25 and X1/26 are used for the communication (via Modbus or Bacnet protocol) with an external-control-device (e.g. PLC, BMS or a PC too); a dedicated termination resistor switch (BUS2, see image below) is made available to add a parallel terminator resistor to this RS485 port: if the resistor is needed put BUS2 switch on ON position.

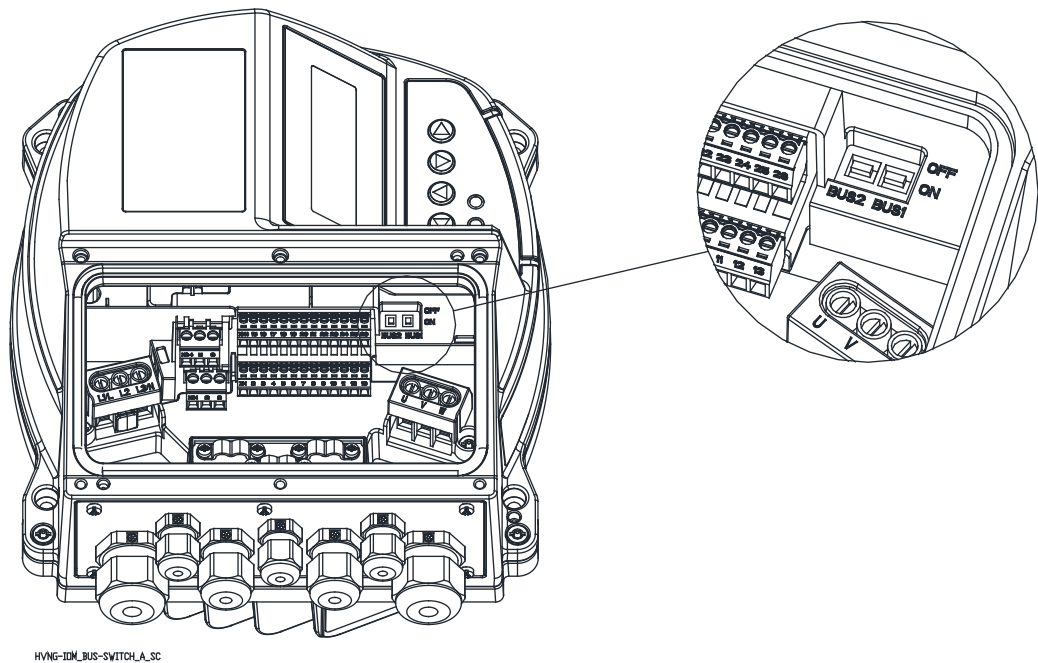

Table 9: RS485 ports

Terminals	Description	Comments
X1/11	RS485 port 1: RS485-1N	RS485 port 1 for multi-pump systems
X1/12	RS485 port 1: RS485-1P	
X1/13	GND, electronic ground	
BUS1	Termination resistor for port 1	
X1/24	RS485 port 2: RS485-2N	RS485 port 2 for external communication
X1/25	RS485 port 2: RS485-2P	
X1/26	GND, electronic ground	
BUS2	Termination resistor for port 2	

6.6.5 Status relays

Terminals X2/4, X2/5 and X2/6 are used to make available Status Relay 1 contacts, for driving an external relay used as pump status configurable indicator.

Terminals X2/1, X2/2 and X2/3 are used to make available Status Relay 2 contacts, for driving an external relay used as pump status configurable indicator.

Table 10: Status relays

Terminals	Description	Comments
X2/1	Status Relay 2: NO	Status Relay 2 Maximum 250 VAC, 0.25 A Maximum 220 VDC, 0.25 A Maximum 30 VDC, 2 A
X2/2	Status Relay 2: NC	
X2/3	Status Relay 2: CC	
X2/4	Status Relay 1: NO	Status Relay 1 Maximum 250 VAC, 0.25 A Maximum 220 VDC, 0.25 A Maximum 30 VDC, 2 A
X2/5	Status Relay 1: NC	
X2/6	Status Relay 1: CC	

6.7 Premium card terminals

6.7.1 Digital and analog I/O (X3)

Several terminals, from X3/1 to X3/12, are used to connect additional analog and digital I/Os to correspondent input signals, most of them configurable by specific parameters.

Table 11: PC I/O terminals

Item	Terminals	Description	Comments
Digital Input	X3/1	Configurable digital input 2	Active low
	X3/2	Ground for configurable digital input 2	GND, electronic ground (for X3/1)
Signal 1	X3/3	Analog output signal 1	4-20mA
	X3/4	Ground for analog output signal 1	GND, electronic ground (for X3/3)
Signal 2	X3/5	Analog output signal 2	0-10 VDC
	X3/6	Ground for analog output signal 2	GND, electronic ground (for X3/5)
Sensor 3	X3/7	Power supply for external sensor 3	24VDC, Σ max. 100mA
	X3/8	Actual value current/voltage input sensor 3	0-20mA / 4-20mA / 0-10 VDC / 2-10 VDC
	X3/9	Ground for external sensor 3	GND, electronic ground (for X3/8)
Sensor 4	X3/10	Power supply for external sensor 4	24VDC, Σ max. 100mA
	X3/11	Actual value current/voltage input sensor 4	0-20mA / 4-20mA / 0-10 VDC / 2-10 VDC
	X3/12	Ground for external sensor 4	GND, electronic ground (for X3/11)

6.7.2 Relays (X4)

Several terminals, from X4/1 to X4/6, are used to connect up to 5 fixed speed pumps through an external panel.

Table 12: Relay terminals

Terminals	Description	Comments
X4/1	Relay 1: NO	Maximum 250 VAC, 0.25 A Maximum 220 VDC, 0.25 A Maximum 30 VDC, 0.25 A
X4/2	Relay 2: NO	
X4/3	Relay 3: NO	
X4/4	Relay 4: NO	
X4/5	Relay 5: NO	
X4/6	Ground for relays	

7 Operation

7.1 Pre-start procedure



Electrical Hazard:

If input and output connections have been connected improperly, there is potential for high voltage on these terminals. If power leads for multiple motors are improperly run in same conduit, there is potential for leakage current to charge capacitors within the frequency converter, even when disconnected from mains input. For initial start up, make no assumptions about power components. Follow pre-start procedures. Failure to follow pre-start procedures could result in personal injury or damage to equipment.

1. Make sure input power to unit is OFF and locked out. Do not rely on the frequency converter disconnect switches for input power isolation.
2. In case of 1-phase AC input power, verify that there is no voltage on input terminals L and N, phase-to-phase and phase-to-ground.
3. In case of 3-phase AC input power, verify that there is no voltage on input terminals L1, L2 and L3, phase-to-phase and phase-to-ground.
4. Verify that there is no voltage on output terminals U, V and W, phase-to-phase and phase-to-ground.
5. Confirm continuity of the motor by measuring ohm values on U-V, V-W and W-U.
6. Check for proper grounding of the frequency converter as well as the motor.
7. Inspect the frequency converter for loose connections on terminals.
8. Record the following motor-nameplate data: power, voltage, frequency, full load current, and nominal speed. These values are needed to program motor nameplate data later.
9. Confirm that the supply voltage matches voltage of frequency converter and motor.

7.2 Pre-startup inspections

Item to Inspect	Description	Checked
Auxiliary equipment	<ul style="list-style-type: none"> • Look for auxiliary equipment, switches, disconnects, or input fuses/circuit breakers that may reside on input power side of the frequency converter or output side to motor. Ensure they are ready for full speed operation. • Check function and installation of any sensors used for feedback to the frequency converter. • Remove power factor correction caps on motor(s), if present. 	
Cable routing	<ul style="list-style-type: none"> • Ensure that input power, motor wiring and control wiring are separated or in three separate metallic conduits for high frequency noise isolation. 	
Control wiring	<ul style="list-style-type: none"> • Check for broken or damaged wires and connections. • Check that control wiring is isolated from power and motor wiring for noise immunity. • Check the voltage source of the signals, if necessary. • The use of shielded cable or twisted pair is recommended. Ensure that the shield is terminated correctly. 	
Cooling clearance	<ul style="list-style-type: none"> • Measure that top and bottom clearance is adequate to ensure proper air flow for cooling. 	
EMC considerations	<ul style="list-style-type: none"> • Check for proper installation with regard to electromagnetic capability. 	
Environmental conditions	<ul style="list-style-type: none"> • See equipment tech label for the maximum ambient operation temperature limits. • Humidity levels must be 5-95% non-condensing. 	
Fusing and circuit breakers	<ul style="list-style-type: none"> • Check for proper fusing or circuit breakers. • Check that all fuses are inserted firmly and in operational condition and that all circuit breakers are in the open position. 	

Item to Inspect	Description	Checked
Grounding (earthing)	<ul style="list-style-type: none"> Check for good earth connections (ground connections) that are tight and free of oxidation. Grounding (earthing) to conduit is not a suitable ground (earth) . 	
Input and output power wiring	<ul style="list-style-type: none"> Check for loose connections. Check that motor and mains are in separate conduit or separated screened cables. 	
Switches	<ul style="list-style-type: none"> Ensure that all switch and disconnect settings are in the proper positions. 	
Vibration	<ul style="list-style-type: none"> Check that the unit is mounted solidly. Check for an unusual amount of vibration. 	

Checked by:

Date:

7.3 Apply power

NOTICE:

- **HIGH VOLTAGE.** Frequency converters contain high voltage when connected to AC mains. Installation, start-up and maintenance should be performed by qualified personnel only. Failure to comply could result in death or serious injury.
- **UNINTENDED START.** When the frequency converter is connected to AC mains, the motor may start at any time. The frequency converter, motor, and any driven equipment must be in operational readiness. Failure to comply could result in death, serious injury, equipment, or property damage.
- **POTENTIAL HAZARD IN THE EVENT OF INTERNAL FAILURE!** Risk of personal injury when the frequency converter is not properly closed. Before applying power, ensure all safety covers are in place and securely fastened.

1. Confirm that the input voltage is balanced with 3%. If not, correct voltage imbalance before proceeding. Repeat this procedure after the voltage correction.
2. Ensure that optional equipment wiring, if present, matches the installation application.
3. Ensure that all operator and start enable devices are in the OFF position. Panel doors should be closed or cover mounted.
4. Apply power to the unit. **DO NOT** start the frequency converter at this time. For units with a disconnect switch, turn to the ON position to apply power to the frequency converter.

7.4 Discharge time



WARNING:

Disconnect and lock out electrical power and wait for the minimum waiting time specified below. Failure to wait the specified time after power has been removed before performing service or repair could result in death or serious injury.

Frequency converters contain DC-link capacitors that can remain charged even when the frequency converter is not powered. To avoid electrical hazards, disconnect:

- AC mains
- Any permanent magnet type motors
- Any remote DC-link power supplies, including battery backups, ups and DC-link connections to other frequency converters.

Wait for the capacitors to discharge completely before performing any service or repair work. Refer to the following table for wait times:

HVL	Minimum waiting times (min)
2.015 ÷ 2.040	15
3.015 ÷ 3.055	4

HVL	Minimum waiting times (min)
3.075 ÷ 3.110	15
4.015 ÷ 4.110	4
4.150 ÷ 4.220	15

High voltage may be present even when the warning LED indicator lights are off.

8 Programming

Notice

NOTICE:

Read and follow the operating instructions carefully before you start programming. This is to prevent incorrect settings which cause malfunction. All modifications must be done by qualified technicians!

8.1 Display and control panel

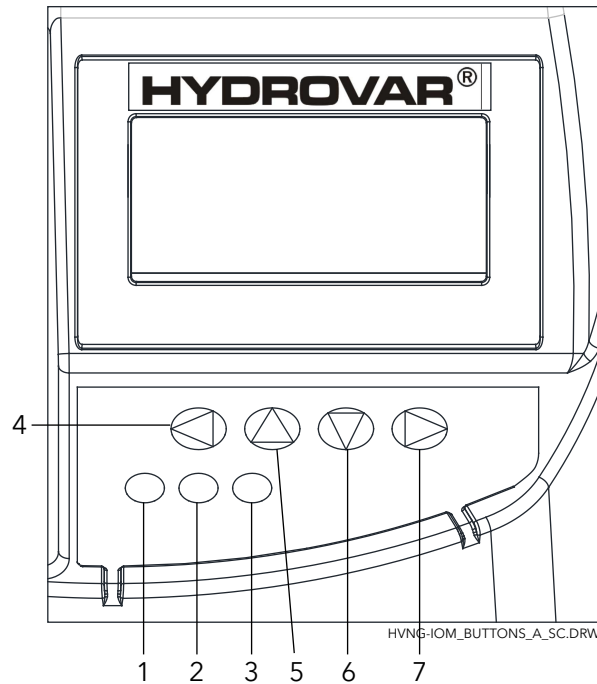

1. Power
2. Run
3. Error
4. Left
5. Up
6. Down
7. Right

8.2 Functions of push buttons

Push button	Description
▲	Start of the unit in the 1 st window.
▼	Stop of the unit in the 1 st window.
◀ and ▶	Reset: press both buttons simultaneously for 5 seconds.
▲	Increase of a value / selection of the submenu.
▼	Decrease of a value / selection of the submenu.
▲ + short ▼	Change to faster scrolling up of a value.
▼ + short ▲	Change to faster scrolling down of a value.
Short press ▶	Enter submenu / change to next parameter in the menu.
Short press ▶	Leave submenu / change to previous parameter in the menu.
Long press ▶	Change back to main menu.

Functions associated to each push button may change, but they are shown in every moment, for reference, on the lowest row of the display.

8.3 Software parameters

Parameters are organized in 2 distinct groups:

- The set of parameters only defining menus
- The set of parameters necessary for HYDROVAR configuration

Referring to the first set (those parameters defining menus), each of them is presented with an image of the display containing (for example) the following information:

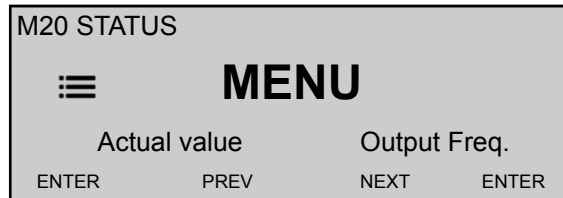

where:

- M20: is the Menu number
- STATUS: is the Menu name
- **Actual value**: is the input signal supplied by the selected transducer (set by submenu 400), expressed with the dimension unit set by parameter 405
- **OUTPUT FREQ.:** current frequency supplied by the drive to the motor
- ENTER/PREV/NEXT: actual functions of the related push buttons

Referring to the second set (those parameters configuring HYDROVAR), each of them is presented with an image of the display containing (for example) the following information:

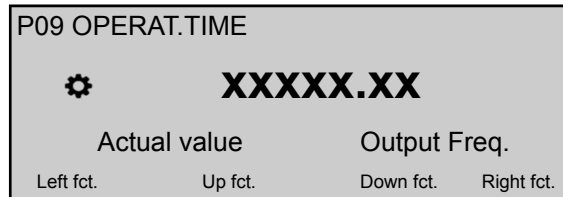

where:

- P09: is the parameter number
- **OPERAT.TIME**: is the parameter name
- XXXXX.XX: is the current parameter value
- **Actual value**: is the input signal supplied by the selected transducer (set by submenu 400), expressed with the dimension unit set by parameter 405
- **Output frequency**: current frequency supplied by the drive to the motor
- Left/Up/Down/Right fct.: actual functions of the related push buttons

The parameters are applicable for all HYDROVAR with the following exceptions:

- If a setting is transferred automatically on all HYDROVAR within one system, this is marked with the symbol (Global):
- If a parameter is read-only, this is marked with the symbol (Read-only):



8.3.1 M00 MAIN MENU

Menu scope

This submenu includes the following software parameters:

- Home
- Selection of required value
- Regulation restart value
- Language selection
- Date and time setup
- Auto - start
- Operating hours

HOME

The information shown on the display depends on the selection done in parameter 105 **MODE**; for more details, see [P105 MODE](#) (page 55)

When P105 **MODE** is set to **Controller** or **Actuator**, display shows the following information:

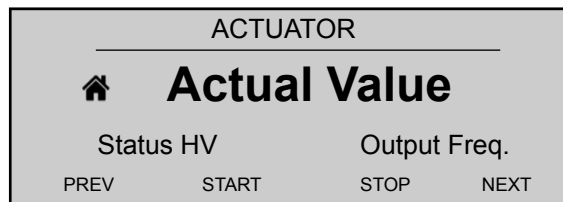
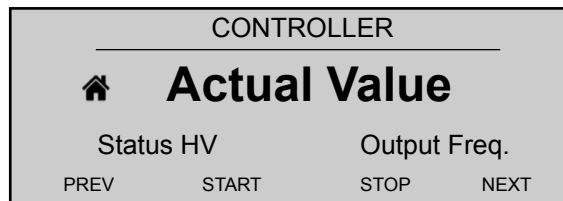

where:

- **Actual value**: is the input signal supplied by the selected transducer (set by menu 400)
- **Status HV**: is the HYDROVAR status (ON / OFF / STOP) depending on manual setting on push buttons and external contact X1/18-19)
- **Output frequency**: current frequency supplied by the drive to the motor
- **PREV/START/STOP/NEXT**: actual functions of the related push buttons

When parameter 105 **MODE** is set to **Cascade Relay**, display shows the following information:

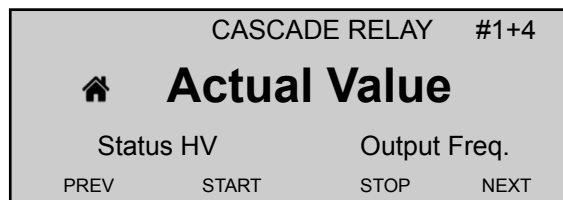

where:

- **Cascade Relay**: is the value of parameter 105
- **#1+4**: is the indication that the system is running with 1 Master (#1) and, for example, 4 fixed speed pumps (+4)
- **Actual value**: is the input signal supplied by the selected transducer (set by menu 400)

- Status HV: is the HYDROVAR status (ON / OFF / STOP) depending on manual setting on push buttons and external contact X1/18-19)
- **Output frequency:** current frequency supplied by the drive to the motor
- PREV/START/STOP/NEXT: actual functions of the related push buttons

When 105 **MODE** is set to **Cascade Serial** or **Cascade Synchron**, display shows the following information:

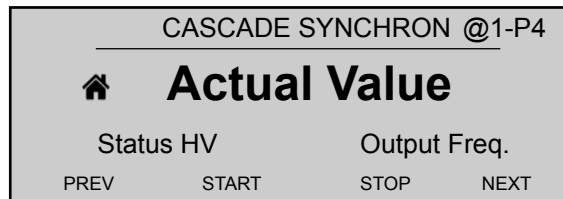
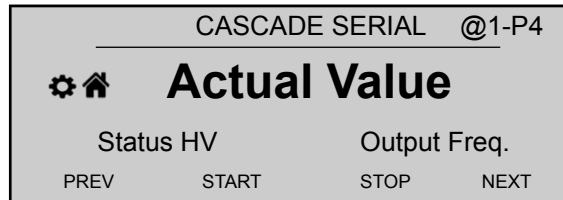

where:

- **Cascade Serial** or **Cascade Synchron:** is the value of parameter 105
- @1: shows, for example, the value of parameter 1220 (**PUMP ADDR.**)
- P4: shows, for example, the address of the pump which is currently acting as Master of the cascade, depending on settings of menu 500
- **Actual value:** is the input signal supplied by the selected transducer (set by menu 400)
- Status HV: is the HYDROVAR status (ON / OFF / STOP) depending on manual setting on push buttons and external contact X1/18-19)
- **Output frequency:** current frequency supplied by the drive to the motor
- PREV/START/STOP/NEXT: actual functions of the related push buttons

P02 REQUIRED VAL. G

The information shown on the display depend on the selection done in parameter 105; for more details, see [P105 MODE](#) (page 55)

When parameter 105 **MODE** is set to **Controller**, **Cascade Relay**, **Cascade Serial** or **Cascade Synchron**, display shows the following information:

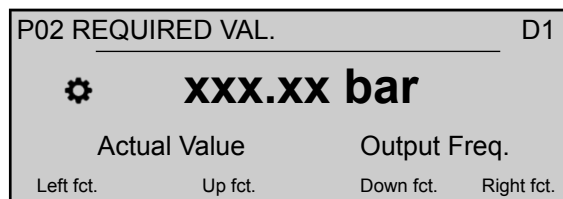

where:

- **REQUIRED VAL.:** is the parameter description
- D1: is (for example) the selected source for the parameter, set by submenu 800
- XXX.XX: is the current parameter value
- bar: is the dimension unit set by parameter 405
- **Actual value:** is the input signal supplied by the selected transducer (set by submenu 400), expressed with the dimension unit set by parameter 405

- **Output frequency:** current frequency supplied by the drive to the motor
- Left/Up/Down/Right: actual functions of the related push buttons

When parameter 105 **MODE** is set to **Actuator**, display shows the following information:

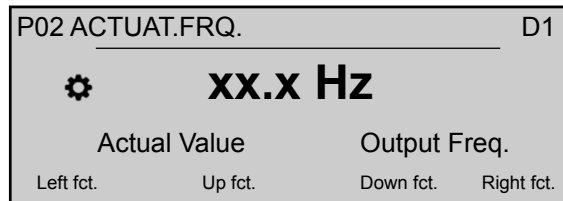

where:

- **ACTUAT.FRQ.1.:** is the parameter description
- D1: is (for example) the selected source for the parameter, set by submenu 800
- XX.X: is the current parameter value
- Hz: is the dimension unit
- **Actual value:** is the input signal supplied by the selected transducer (set by submenu 400), expressed with the dimension unit set by parameter 405
- **Output frequency:** current frequency supplied by the drive to the motor
- Left/Up/Down/Right: actual functions of the related push buttons

P03 EFF.REQ.VAL.

The information shown on the display depends on the selection done in par. 105; for more details, see [P105 MODE](#) (page 55)

When parameter 105 **MODE** is set to **Controller**, **Cascade Relay**, **Cascade Serial** or **Cascade Synchron**, display shows the following information:

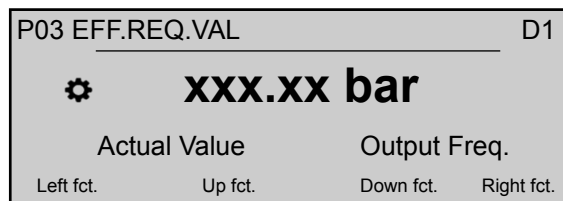

where:

- **EFF.REQ.VAL.:** is the parameter description
- D1: is (for example) the selected source for the parameter, set by submenu 800
- XXX.XX: is the current parameter value
- bar: is the dimension unit set by parameter 405
- **Actual value:** is the input signal supplied by the selected transducer (set by submenu 400), expressed with the dimension unit set by parameter 405
- **Output frequency:** current frequency supplied by the drive to the motor
- Left/Up/Down/Right: actual functions of the related push buttons

When parameter 105 **MODE** is set to **Actuator**, P03 is not shown!

Parameter 03 **EFF.REQ.VAL.** shows the current required value that is calculated based on parameter 505 **ACT.VAL.INC.**, parameter 510 **ACT.VAL.DEC.** and parameter 330 **LIFT AMOUNT**. If the required value is influenced by an offset signal (set by submenu 900), then the current active required value is also shown in this window.

P04 START VALUE **G**

P04 START VALUE			
⚙️ 100%			
Actual Value		Output Freq.	
Left fct.	Up fct.	Down fct.	Right fct.

This parameter defines, in percentage (0-100%) of the required value (P02 **REQUIRED VAL.**), the start value after pump stops.

If P02 **REQUIRED VAL.** is met and there is no more consumption, then the pump stops. The pump starts again when the pressure drops below P04 **START VALUE.**

Value 100% makes this parameter not effective (100%=off)!

P05 LANGUAGE

P05 LANGUAGE			
⚙️ English			
Actual Value		Output Freq.	
Left fct.	Up fct.	Down fct.	Right fct.

This parameter selects the display language.

P06 DATE

P06 DATE			
⚙️ XX.XX.20XX			
Actual Value		Output Freq.	
Left fct.	Up fct.	Down fct.	Right fct.

This parameter set current date.

P07 TIME

P07 TIME			
⚙️ HH.MM			
Actual Value		Output Freq.	
Left fct.	Up fct.	Down fct.	Right fct.

This parameter set current time.

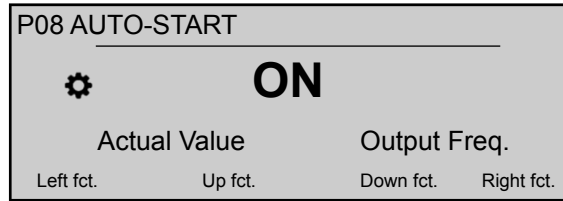
P08 AUTO-START 

If **AUTO-START = On**, then the HYDROVAR starts automatically (in case of demand) following a power disconnection.

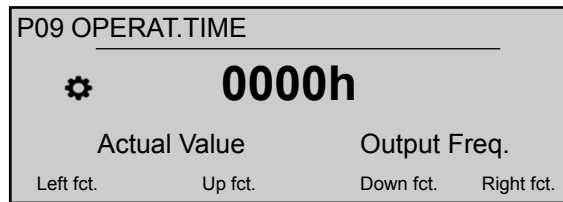
P09 OPERAT.TIME 

This parameter shows the total operating time (in hours).

For an instruction on how to reset the counter, see P1135 **CLR.OPERAT..**

8.3.2 M20 STATUS

MENU SCOPE

Using this submenu it is possible to check the status (including failures and motor hours) of all connected units.

P21 STATUS UNITS  

This parameter gives a overview about the status of the connected units.

The information shown on the display depend on the selection done in parameter 105 **MODE**; for more details, see [P105 MODE](#) (page 55).

When parameter 105 **MODE** is set to **Cascade Serial** or **Cascade Synchron**, display shows (for example) the following information:

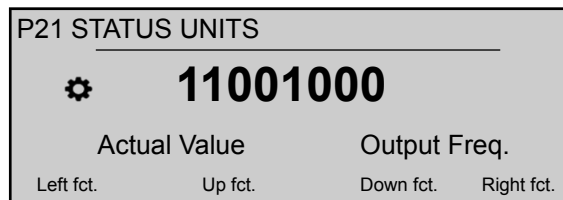

where the status of all (max. 8) connected units is shown (whereas 1=activated / 0=deactivated).

When parameter 105 **MODE** is set to **Cascade Relay**, display shows (for example) the following information:

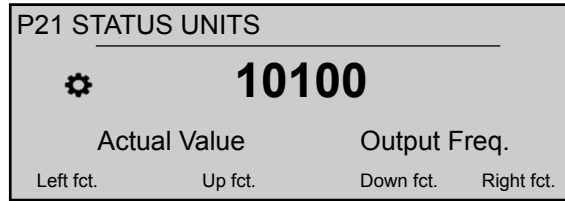

where (HYDROVAR is equipped with additional Premium Card) the status of the 5 Relay-switching contacts is shown. (where as 1=activated / 0=deactivated).

P22 SELECT DEVICE

This parameter lets the user select a specific unit (1-8) in a cascade system, so that current status, motor hours and last failures occurred can be checked.

The information shown on the display depends on the selection done in parameter 105 **MODE**; for more details, see [P105 MODE](#) (page 55).

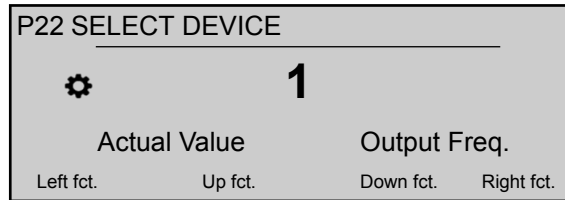

When P105 **MODE** is set to **Cascade Serial** or **Cascade Synchron**, the value selected for P22 **SELECT DEVICE** specifies the address of the HYDROVAR units,

When P105 **MODE** is set to **Cascade Relay**, the value selected for P22 **SELECT DEVICE** follows the subsequent table:

Device	enabled by	
1	MASTER Inverter	
2	fixed speed pump	Relay 1 X4 /1
3	fixed speed pump	Relay 2 X4 /2
4	fixed speed pump	Relay 3 X4 /3
5	fixed speed pump	Relay 4 X4 /4
6	fixed speed pump	Relay 5 X4 /5
7	N/A	N/A
8	N/A	N/A

P23 STATUS DEVICE  

This parameter shows the status of the selected device (by means of parameter 22 **SELECT DEVICE**).

The information shown on the display depend on the selection done in parameter 105 **MODE**; for more details, see [P105 MODE](#) (page 55).

When P105 **MODE** is set to **Cascade Serial** or **Cascade Synchron**, display shows (for example) the following information:

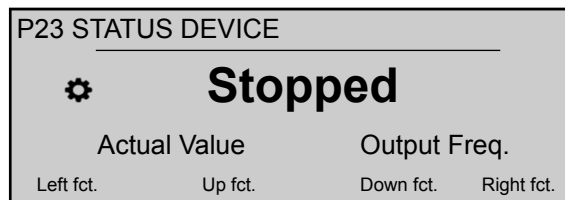

where the value displayed may change as per the following table:

Displayed value	Description
Running	The pump runs.
Stopped	The pump is stopped since the pump is not requested.
Disabled	The pump is manually stopped using the: - buttons - parameter P24 ENABLE DEVICE - external device
OFF	The pump is not connected to the power supply or the RS485.
Preparing	A new unit is connected to the system and data is transferring.
Fault	A failure that occurred on the current unit.

When P105 **MODE** is set to **Cascade Relay**, the value displayed may change as per the following table:

Displayed value	Description
Relay On	The relay contact is closed and the fixed-speed pump operates.
Relay Off	The relay contact is open and the fixed-speed pump is stopped
Fault	A failure that occurred on the current unit.

P24 ENABLE DEVICE



By using this parameter, the user can manually enable and disable the selected device (by means of parameter 22 **SELECT DEVICE**).

When parameter 105 **MODE** is set to **Controller**, **Cascade Relay**, **Cascade Serial** or **Cascade Synchron**, display shows the following information:

P24 ENABLE DEVICE			
Enabled			
Actual Value		Output Freq.	
Left fct.	Up fct.	Down fct.	Right fct.

where possible settings are "**Enabled**" or "**Disabled**".

P25 MOTOR HOURS



This parameter shows the operation time in hours of the selected device. Thus, the time period during which HYDROVAR has powered the motor.

P25 MOTOR HOURS			
XXXXX h			
Actual Value		Output Freq.	
Left fct.	Up fct.	Down fct.	Right fct.

For information about how to reset the count, see parameter 1130 **CLR.MOTOR H**.

P26 thru P30: ERROR memory



These parameters hold the error memory information. All errors are saved and shown in these parameters.

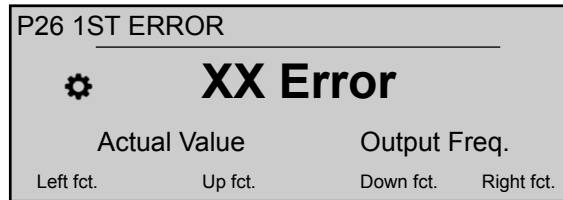

The errors include the following information:

- XX = error code / Error = description
- Date and time of when the error occurred

P35 KWH COUNTER



This parameter registers the power consumption of the motor as a mean value over 1 hour.

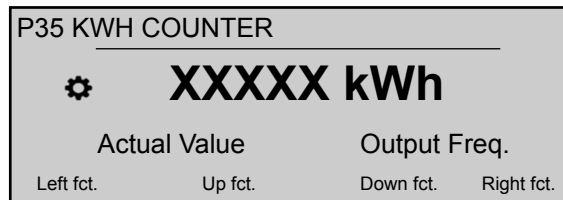

For information about how to reset the counter, see parameter 1140 CLR.KWH CNT.

8.3.3 M40 DIAGNOSTICS

MENU SCOPE

This submenu includes the following software parameters:

- Production date
- Actual temperature
- Actual output current
- Actual input voltage
- Actual output frequency
- Software version of the Power Board

During operation, the information in these parameters is read-only. No changes are permitted.

P41 PROD.DATE



Shows the production date of the control board; the display format is YYYYWW (year, week).

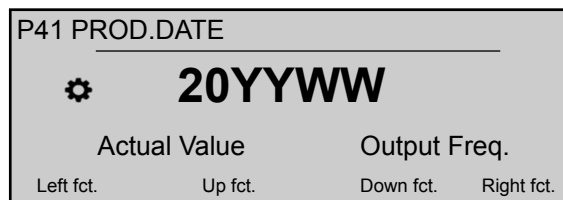

P42 SEL.INVERTER 

Select the desired inverter unit (1-8).

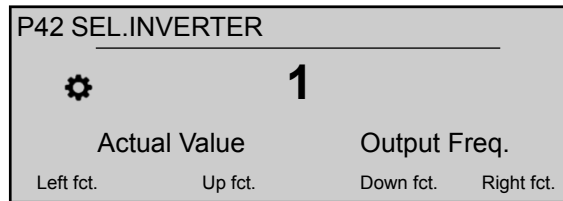
P43 TEMP.INVERTER  

Shows the temperature inside the selected (by mean of parameter 42) unit,

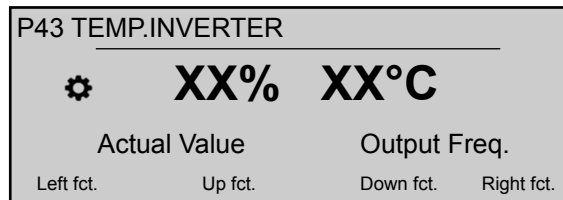

with the following data:

- Temperature inside (°C)
- % of the maximum temperature

P44 CURR.INVERTER  

Shows the output current in percentage of the maximum rated current for the selected (by mean of parameter 42) unit.

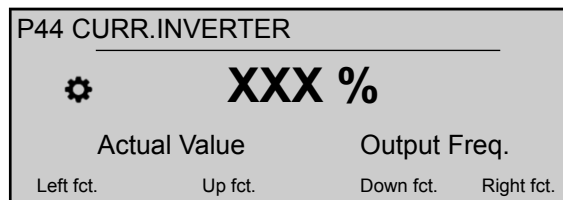
P45 VOLT.INVERTER  

Shows the input voltage (V) for the selected (by mean of parameter 42) unit.

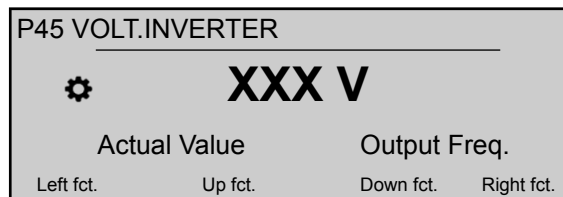
P46 OUTPUT FREQ.  

Shows the output frequency (Hz) for the selected (by mean of parameter 42) unit.

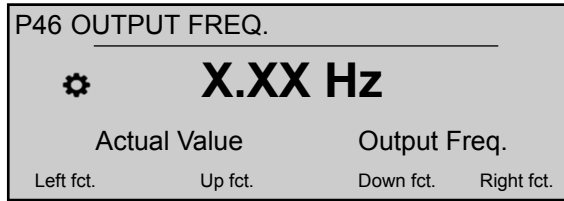

P47 VER.INVERTER : POWER  

Shows information about the software version of the power board for the selected (by means of parameter 42) unit.

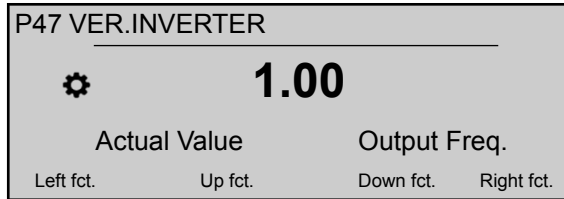

For details, see table below.

Displayed value	Versions (power sizes)	Additional information
1.00	All	First Release 12/2015

8.3.4 M60 SETTINGS

MENU SCOPE

This submenu includes the following software parameters:

- PASSWORD
- JOG



CAUTION:

Read these instructions carefully before changing any parameter in this sub menu. The settings must be carried out by trained and qualified persons. Incorrect settings will cause malfunction.

It is possible to change all parameters during operation, but it is highly recommended that the unit is stopped when changing parameters.

P61 PASSWORD

Enter the system password, which gives access to all system parameters: default setting is 00066.

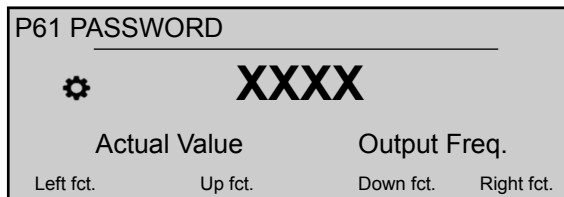

When a correct password is entered, the system remains unlocked for 10 minutes.

For this parameter please note that, once entered into edit mode (by pressing the provided push button), the user can confirm the new value by pressing for 3 sec the right (▶) push button.

P62 JOG

This parameter deactivates the internal controller of HYDROVAR and changes to manual mode. Display shows the following information:

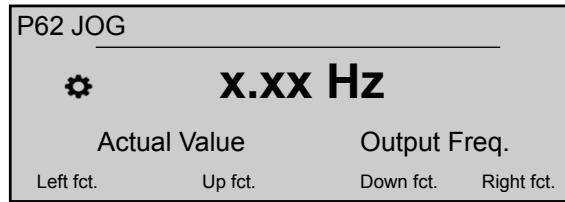

Where:

- **JOG:** is the parameter description
- **X.XX:** is the current parameter value (0Hz - P245 **MAX.FREQ.**); at 0.0 Hz, the unit stops.
- **Actual value:** is the input signal supplied by the selected transducer (set by submenu 400), expressed with the dimension unit set by parameter 405
- **Output frequency:** current frequency supplied by the drive to the motor
- Left/Up/Down/Right fct.: actual functions of the related push buttons

8.3.5 M100 BASIC SETTINGS

MENU SCOPE

This submenu includes the following software parameters:

- Operation mode
- Pump address
- Password
- Lock function
- Display contrast
- Display brightness

P105 MODE

By using this parameter, the user can select an operation mode.

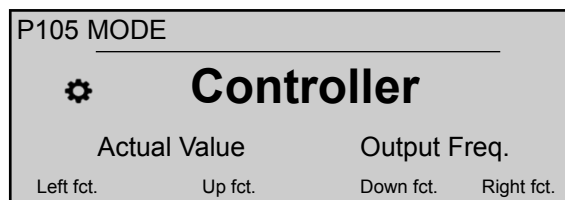

where possible settings are:

MODE	Operable unit(s)
Controller (Default)	1 Hydrovar
Cascade Relay	1 Hydrovar and Premium Card
Cascade Serial	More than one pump
Cascade Synchron	All pumps operate on the same frequency
Actuator	1 Hydrovar

The **Actuator** mode is used if the HYDROVAR is a standard VFD with:

- Fixed speed requirements or
- An external speed signal is connected.

For more information, see [Example: P105 ACTUATOR mode](#) (page 102).

P106 PUMP ADDR.

Selects an address (1-8) for each HYDROVAR

P106 PUMP ADDR.			
		1	
Actual Value		Output Freq.	
Left fct.	Up fct.	Down fct.	Right fct.

If several MASTER inverters are connected via the internal RS-485 interface (maximum eight in **Cascade Serial** mode), then the following must apply:

- Each HYDROVAR needs an individual pump-address (1-8)
- Each address can only be used once.

P110 SET PASSW.

Set a system password (00000 - 09999); default setting is 00066.

P110 SET PASSW.			
		00066	
Actual Value		Output Freq.	
Left fct.	Up fct.	Down fct.	Right fct.

P115 LOCK FUNCT.

By using this parameter, the user can lock or unlock parameter settings in the main menu.

P115 LOCK FUNCT.			
		Off	
Actual Value		Output Freq.	
Left fct.	Up fct.	Down fct.	Right fct.

where possible settings are:

Setting	Description
ON	No parameters can be changed without the system password.
OFF	All parameters in the main menu can be changed.

P120 DISP.CONTR.

Adjust the display contrast (10 - 100%)

P120 DISP.CONTR.			
		75 %	
Actual Value		Output Freq.	
Left fct.	Up fct.	Down fct.	Right fct.

P125 DISP.BRIGHT.

Adjust the backlight brightness of the display (10 - 100%)

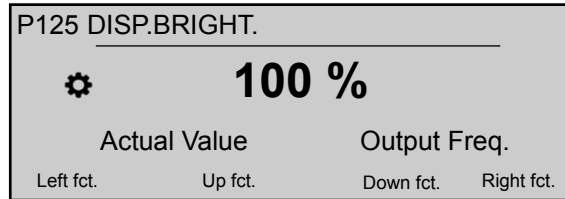

P130 DISP.ROTATION

This parameter enables the rotation, by 180°, of display and push buttons relative to standard position.

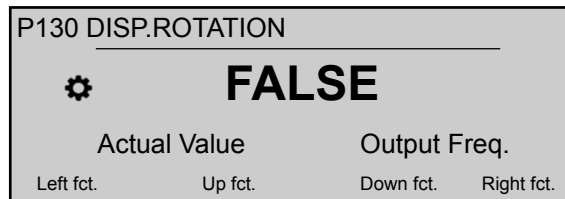

P135 BACK.COMP.

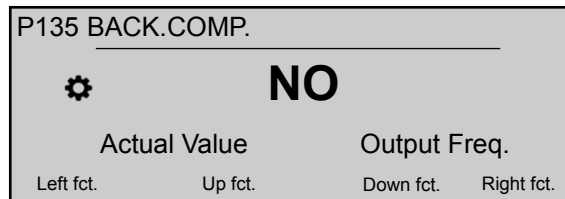

This parameter activates the Backward Compatibility mode: when set to YES, it forces HYDROVAR to work in a multi-pump application acting and communicating as the previous generation HYDROVAR (HV 2.015-4.220).

HVL and HV 2.015-4.220 multi-pump communication protocol are not compatible! Thus in a multi-pump application where there is present at least one previous generation HYDROVAR (HV 2.015-4.220), all the other HVL model shall be forced in backward compatibility mode. For further information check the dedicated HVL Backward compatibility Set-up and programming guide.

8.3.6 M200 CONF.INVERTER

MENU SCOPE

This submenu includes the following software parameters:

- Software
- Number of units
- Ramp settings
- Motor settings
- Frequency settings
- STC protection

P202 SOFTWARE



Shows information about the software version of the control board.

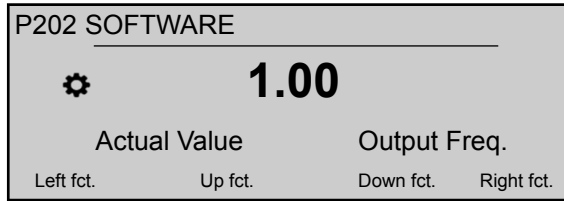

For details, see the table below.

Displayed value	Additional information
1.00	First Release 12/2015

P205 MAX.UNITS G

Set the maximum number of units that operate simultaneously.

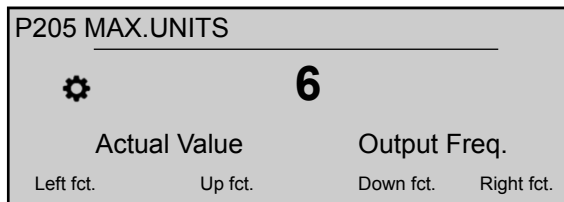

Reasonable values are:

Value	MODE
1-8	Cascade Serial
2-6	Cascade Relay

P210 INVERTER G

Select the HYDROVAR address for parameterization.

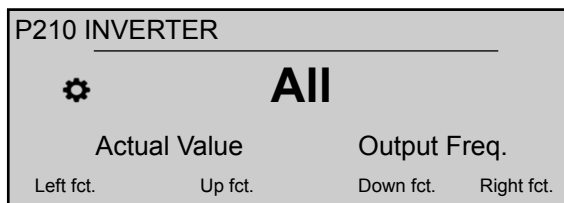

Possible settings are:

Setting	Description
All	All units in the group are programmed at the same time; in any case all new settings are copied to all units.
1-8	Used if one specific unit is programmed. Select that unit (1-8).

P215 RAMP 1 G

NOTICE:

- Fast running up time can cause errors (overload) during the startup.
- Slow running up time can cause a drop of the outgoing operating pressure.



This parameter adjusts the fast acceleration time, and it effects the control of the pump; the ramp depends on the type of HYDROVAR and the type of pump.

HVL	Possible setting (sec)	Default setting (sec)
2.015 ÷ 2.040	1-250	4
3.015 ÷ 3.040		
4.015 ÷ 4.040		
3.055 ÷ 3.110	1-1000	8
4.055 ÷ 4.110		
4.150 ÷ 4.220	1-1000	12

For more information, see [Example: P200 Ramp Settings](#) (page 102).

P220 RAMP 2 G

NOTICE:

- Fast running down time often causes overvoltage.
- Slow running down time often causes over-pressure.

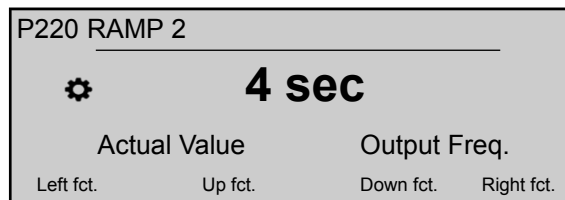

This parameter adjusts the fast deceleration time, and it effects the control of the pump; the ramp depends on the type of HYDROVAR and the type of pump.

HVL	Possible setting (sec)	Default setting (sec)
2.015 ÷ 2.040	1-250	4
3.015 ÷ 3.040		
4.015 ÷ 4.040		
3.055 ÷ 3.110	1-1000	8
4.055 ÷ 4.110		
4.150 ÷ 4.220	1-1000	12

For more information, see [Example: P200 Ramp Settings](#) (page 102).

P225 RAMP 3 G

NOTICE:

- Fast running up time can cause oscillation and overload.
- Slow running up time can cause a drop of the outgoing operating pressure, during variation of the demand.

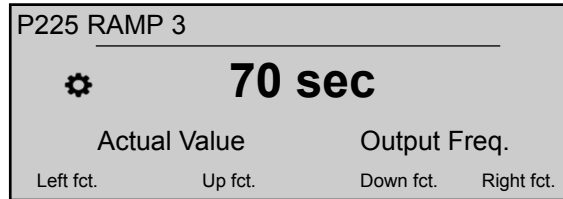

This parameter adjusts the slow acceleration time, thus determining:

- The regulation speed of the internal HYDROVAR controller for small changes in demand.
- The constant outgoing pressure.

The ramp (default value 70 sec, possible setting 1-1000 sec) depends on the system which has to be controlled. For more information, see [Example: P200 Ramp Settings](#) (page 102).

P230 RAMP 4 G

NOTICE:

- Fast running down time can cause oscillation of the unit and the pump
- Slow running down time can cause pressure fluctuations during variation of the demand.

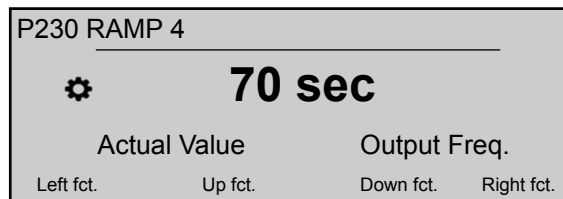

This parameter adjusts the slow deceleration time, thus determining:

- The regulation speed of the internal HYDROVAR controller for small changes in demand.
- The constant outgoing pressure.

The ramp (default value 70 sec, possible setting 1-1000 sec) depends on the system which has to be controlled. For more information, see [Example: P200 Ramp Settings](#) (page 102).

P235 RAMP FMIN A G

NOTICE:

Fast running up time can cause errors (overload) during start.

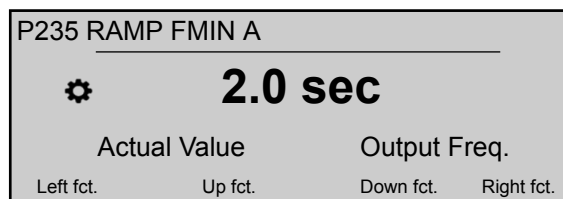

This parameter (default value 2.0 sec, possible setting 1.0- 25.0 sec) sets the ramp Fmin acceleration (fast running up time), and it operates HYDROVAR until the selected P250 **MIN.FREQ.** is reached; after Fmin is passed, P215 **RAMP 1** starts to work. For more information, see [Example: P200 Ramp Settings](#) (page 102).

P240 RAMP FMIN D G**NOTICE:**

Fast running down time often causes overvoltage.

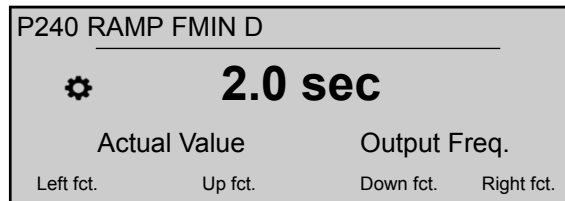

This parameter (default value 2.0 sec, possible setting 1.0- 25.0 sec) sets the ramp Fmin deceleration (fast running down time), and it stops HYDROVAR when it gets below P250 **MIN.FREQ.** For more information, see Example: P200 Ramp Settings.

P245 MAX.FREQ. G**NOTICE:**

Settings higher than standard can cause overload of the motor.

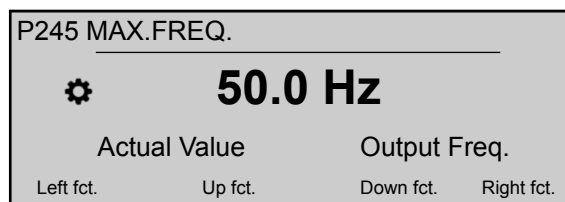

This parameter (default value 50 Hz, possible setting 30.0- 70.0 Hz) sets the maximum frequency, and thus the maximum speed of the pump; the standard setting according to the nominal frequency of the connected motor.

P250 MIN.FREQ. G**NOTICE:**

The minimum frequency depends on the selected pump type and application. For borehole applications in particular, the minimum frequency must be set to ≥ 30 Hz*.

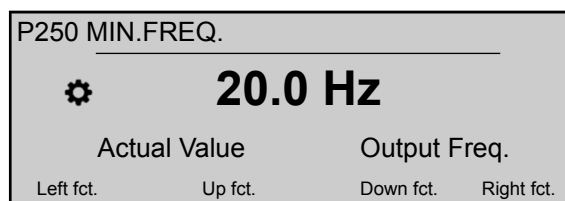

This parameter (default value 20 Hz, possible setting 0.0 Hz- P245 **MAX.FREQ.**) sets the minimum frequency; operations below this value are done with P235 **RAMP FMIN A** and P240 **RAMP FMIN D**.

P255 CONF.FMIN G

This parameter defines the operation at minimum frequency.

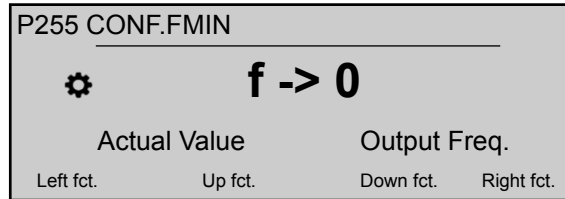

Possible settings are:

Setting	Description
f -> 0	Once the required pressure is reached and no further consumption is needed, the frequency goes down to the selected P250 MIN.FREQ. : HYDROVAR will then keep running for the selected P260 FMIN TIME and after this time stops automatically.
f -> fmin	With this setting the pump never stop automatically: the frequency goes down to the selected P250 MIN.FREQ. . To stop the pump the external ON/OFF must be opened or the provided push button must be pressed.

NOTICE:

For circulation systems, the setting "f -> fmin" can overheat the pump in case there is no flow through it!

P260 FMIN TIME G

This parameter (default value 0 sec, possible setting 0-100 sec) sets the delay time before a shut-off below P250 **MIN.FREQ.** occurs.



It is used to prevent problems with a shut off of the pump at no demand (too small or no pressure tank), as the system pressure increases during this delay time. This parameter is only active if P255 **CONF.FMIN** is set to "f -> 0".

P261 SKIP FRQ.CTR. G

This parameter (possible setting P250 **MIN.FREQ.** - P245 **MAX.FREQ.**) sets the skip frequency center.

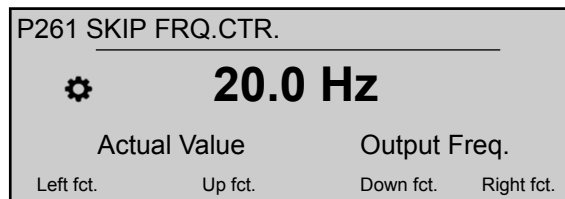

P262 SKIP FRQ.RNG. G

This parameter (possible setting 0.0 - 5.0 Hz) sets the skip frequency range.

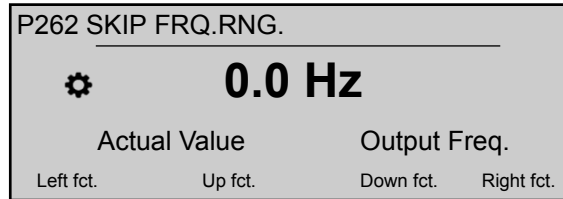

P265 MOTOR NOM.POWER

Sets the nominal power of the motor coupled with HYDROVAR, as reported in the motor nameplate.

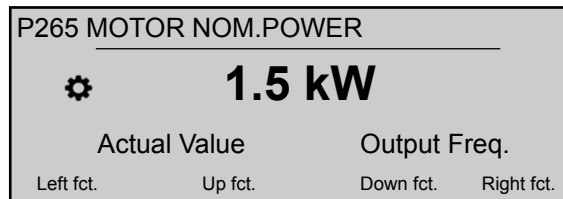

Possible settings are:

HVL	Undersized motor 2	Undersized motor 1	Default	Oversized motor
2,015	0.75 kW - 1.0 hp	1.1 kW - 1.5 hp	1.5 kW - 2.0 hp	2.2 kW - 3.0 hp
2,022	1.1 kW - 1.5 hp	1.5 kW - 2.0 hp	2.2 kW - 3.0 hp	3.0 kW - 4.0 hp
2,030	1.5 kW - 2.0 hp	2.2 kW - 3.0 hp	3.0 kW - 4.0 hp	4.0 kW - 5.0 hp
2,040	2.2 kW - 3.0 hp	3.0 kW - 4.0 hp	4.0 kW - 5.0 hp	5.5 kW - 7.5 hp
3,015	0.75 kW - 1.0 hp	1.1 kW - 1.5 hp	1.5 kW - 2.0 hp	2.2 kW - 3.0 hp
3,022	1.1 kW - 1.5 hp	1.5 kW - 2.0 hp	2.2 kW - 3.0 hp	3.0 kW - 4.0 hp
3,030	1.5 kW - 2.0 hp	2.2 kW - 3.0 hp	3.0 kW - 4.0 hp	4.0 kW - 5.0 hp
3,040	2.2 kW - 3.0 hp	3.0 kW - 4.0 hp	4.0 kW - 5.0 hp	5.5 kW - 7.5 hp
3,055	3.0 kW - 4.0 hp	4.0 kW - 5.0 hp	5.5 kW - 7.5 hp	7.5 kW - 10.0 hp
3,075	4.0 kW - 5.0 hp	5.5 kW - 7.5 hp	7.5 kW - 10.0 hp	11.0 kW - 15.0 hp
3,110	5.5 kW - 7.5 hp	7.5 kW - 10.0 hp	11.0 kW - 15.0 hp	15.0 kW - 20.0 hp
4,015	0.75 kW - 1.0 hp	1.1 kW - 1.5 hp	1.5 kW - 2.0 hp	2.2 kW - 3.0 hp
4,022	1.1 kW - 1.5 hp	1.5 kW - 2.0 hp	2.2 kW - 3.0 hp	3.0 kW - 4.0 hp
4,030	1.5 kW - 2.0 hp	2.2 kW - 3.0 hp	3.0 kW - 4.0 hp	4.0 kW - 5.0 hp
4,040	2.2 kW - 3.0 hp	3.0 kW - 4.0 hp	4.0 kW - 5.0 hp	5.5 kW - 7.5 hp
4,055	3.0 kW - 4.0 hp	4.0 kW - 5.0 hp	5.5 kW - 7.5 hp	7.5 kW - 10.0 hp
4,075	4.0 kW - 5.0 hp	5.5 kW - 7.5 hp	7.5 kW - 10.0 hp	11.0 kW - 15.0 hp
4,110	5.5 kW - 7.5 hp	7.5 kW - 10.0 hp	11.0 kW - 15.0 hp	15.0 kW - 20.0 hp
4,150	7.5 kW - 10.0 hp	11.0 kW - 15.0 hp	15.0 kW - 20.0 hp	18.5 kW - 25.0 hp
4,185	11.0 kW - 15.0 hp	15.0 kW - 20.0 hp	18.5 kW - 25.0 hp	22.0 kW - 30.0 hp
4,220	15.0 kW - 20.0 hp	18.5 kW - 25.0 hp	22.0 kW - 30.0 hp	30.0 kW - 40.0 hp

P266 MOTOR NOM.VOLT.

Sets the motor nominal voltage, as reported in the motor nameplate, according to

- the chosen motor connection
- the output voltage of the HYDROVAR

P266 MOTOR NOM.VOLT.			
 230 V			
Actual Value		Output Freq.	
Left fct.	Up fct.	Down fct.	Right fct.

Possible settings are:

HVL	Possible setting (V)	Default setting (V)
2.015 ÷ 2.040	208-240	230
3.015 ÷ 3.110	208-240	230
4.015 ÷ 4.220	380-460	400

P267 MOTOR NOM.FRQ.

Sets the motor nominal frequency, as reported in the motor nameplate

P267 MOTOR NOM.FRQ.			
 50.0 Hz			
Actual Value		Output Freq.	
Left fct.	Up fct.	Down fct.	Right fct.

P268 MOTOR NOM.CURR.

Sets the motor nominal current, as reported in the motor nameplate, according to

- the chosen motor connection
- the output voltage of the HYDROVAR

P268 MOTOR NOM.CURR.			
 7.5 A			
Actual Value		Output Freq.	
Left fct.	Up fct.	Down fct.	Right fct.

P269 MOTOR NOM.SPEED

Sets the motor nominal speed, as reported in the motor nameplate

P269 MOTOR NOM.SPEED			
 3000 rpm			
Actual Value		Output Freq.	
Left fct.	Up fct.	Down fct.	Right fct.

P270 MOTOR POLES

This parameter (possible setting 2 or 4) sets the number of motor poles (display showing, for example, the following information)

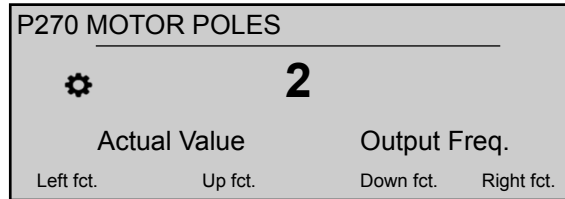

P275 AMPI

NOTICE:

- For the best adaptation of HYDROVAR, run **AMPI** on a cold motor
- **AMPI** cannot be performed while the motor runs
- **AMPI** cannot be performed on a motor with a bigger power rating than HYDROVAR that is, when a 5.5 kW motor is coupled with a 4 kW drive
- Avoid generating external torque during **AMPI**.

This parameter activates the Automatic Motor Parameter Identification; possible settings are "Off" (**AMPI** not active), "Full" or "Reduced" (procedure to be performed only in case LC filters are applied on the motor cable).

For this parameter please note that, once entered into edit mode (by pressing the provided push button), the user can confirm the new value by pressing for 3 sec the right (▶) push button.

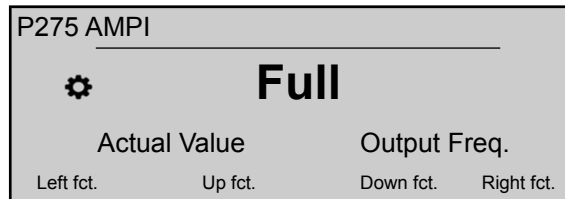

Once the **AMPI** procedure is activated (when either "Full" or "Reduced" option is selected), it takes up to 3 min for the identification of the motor: during this period HYDROVAR prevents the user from any action ("Running" message on the display, push-buttons deactivated).

Possible outcomes are "OK" (**AMPI** succeeded in self-configuring the motor) or "Fault" (**AMPI** result unsuccessful): once one of these two messages is displayed, HYDROVAR unlocks the push buttons to standard related functions.

P280 SWITCHING CONTROL

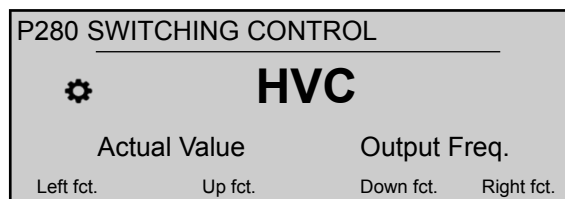

Sets the motor control method. Possible settings are "V/f" or "HVC" (default)

"V/f" represents the Scalar Control: the open loop volts/hertz control of an induction motor is by far most popular method of speed control because of its simplicity.

"HVC" represents the HYDROVAR Vector Control: this method improves dynamic and stability, both when speed reference is changed and in relation to the load torque. This type of control is adaptive to motor load and adaptation to speed and torque changes is less than 3 milliseconds. Motor torque can remain constant regardless to speed changes.

P281 BOOST G**NOTICE:**

- If this parameter is set too low or too high, then there is a risk for overload due to too high starting current.
- Keep the settings as low as possible to reduce the risk of thermal overload of the motor at lower frequencies.

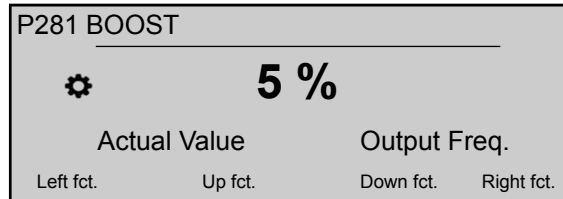

This parameter (possible setting 0-25%) sets the motor starting voltage in % of connected supply voltage, thus determining the characteristics of the voltage/frequency curve.

The default value depends on the type of HYDROVAR:

HVL	Default setting (%)
2.015 ÷ 2.040	5
3.015 ÷ 3.040	
4.015 ÷ 4.040	
3.055 ÷ 3.110	8
4.055 ÷ 4.110	
4.150 ÷ 4.220	10

P282 KNEE FREQ. G**NOTICE:**

This parameter must be used for special applications only. An incorrect setting can cause overload or damage of the motor.

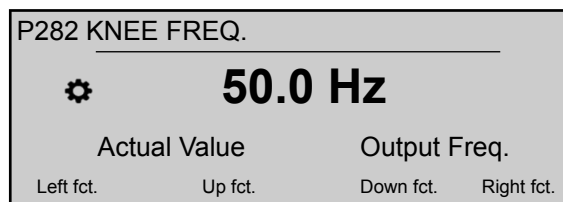

This parameter (default value 50 Hz, possible setting 30.0- 90.0 Hz) sets the knee frequency, where HYDROVAR generates its maximum output voltage. For standard applications, set this value according to nominal frequency of the motor.

P283 SEL.SW.FREQ. G

This parameter sets the switching frequency.

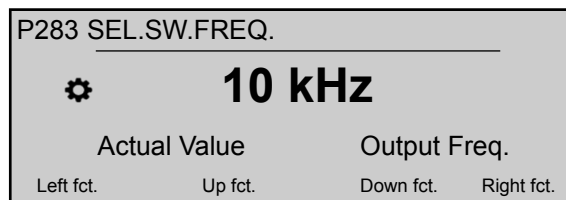

HYDROVAR, in any case, can decrease automatically the switching frequency applying the derating criteria. Possible settings are:

HVL	Possible setting					
					Default	
2,015	Random ~5 kHz	2 kHz	5 kHz	8 kHz	10 kHz	16 kHz
2,022	Random ~5 kHz	2 kHz	5 kHz	8 kHz	10 kHz	16 kHz
2,030	Random ~5 kHz	2 kHz	5 kHz	8 kHz	10 kHz	16 kHz
2,040	Random ~5 kHz	2 kHz	5 kHz	8 kHz	10 kHz	16 kHz
3,015	Random ~5 kHz	2 kHz	5 kHz	8 kHz	10 kHz	16 kHz
3,022	Random ~5 kHz	2 kHz	5 kHz	8 kHz	10 kHz	16 kHz
3,030	Random ~5 kHz	2 kHz	5 kHz	8 kHz	10 kHz	16 kHz
3,040	Random ~5 kHz	2 kHz	5 kHz	8 kHz	10 kHz	16 kHz
3,055	Random ~5 kHz	2 kHz	5 kHz	8 kHz	10 kHz	16 kHz
3,075		2 kHz	4 kHz	8 kHz	10 kHz	16 kHz
3,110		2 kHz	4 kHz	8 kHz	10 kHz	16 kHz
4,015	Random ~5 kHz	2 kHz	5 kHz	8 kHz	10 kHz	16 kHz
4,022	Random ~5 kHz	2 kHz	5 kHz	8 kHz	10 kHz	16 kHz
4,030	Random ~5 kHz	2 kHz	5 kHz	8 kHz	10 kHz	16 kHz
4,040	Random ~5 kHz	2 kHz	5 kHz	8 kHz	10 kHz	16 kHz
4,055	Random ~5 kHz	2 kHz	5 kHz	8 kHz	10 kHz	16 kHz
4,075	Random ~5 kHz	2 kHz	5 kHz	8 kHz	10 kHz	16 kHz
4,110	Random ~5 kHz	2 kHz	5 kHz	8 kHz	10 kHz	16 kHz
4,150		2 kHz	4 kHz	8 kHz	10 kHz	16 kHz
4,185		2 kHz	4 kHz	8 kHz	10 kHz	16 kHz
4,220		2 kHz	4 kHz	8 kHz	10 kHz	16 kHz

P284MIN.SW.FREQ.

G

This parameter sets the minimum switching frequency HYDROVAR can generate.



This parameter is useful to force HYDROVAR to generate:

- switching frequencies in a certain bandwidth (upper limit defined by P283 - lower limit defined by P284)
- a fixed switching frequency (when P283 = P284).

Possible settings are:

HVL	Default				
2,015	2 kHz	5 kHz	8 kHz	10 kHz	16kHz
2,022	2 kHz	5 kHz	8 kHz	10 kHz	16kHz
2,030	2 kHz	5 kHz	8 kHz	10 kHz	16kHz
2,040	2 kHz	5 kHz	8 kHz	10 kHz	16kHz
3,015	2 kHz	5 kHz	8 kHz	10 kHz	16kHz
3,022	2 kHz	5 kHz	8 kHz	10 kHz	16kHz
3,030	2 kHz	5 kHz	8 kHz	10 kHz	16kHz
3,040	2 kHz	5 kHz	8 kHz	10 kHz	16kHz
3,055	2 kHz	5 kHz	8 kHz	10 kHz	16kHz
3,075	2 kHz	4 kHz	8 kHz	10 kHz	16kHz
3,110	2 kHz	4 kHz	8 kHz	10 kHz	16kHz
4,015	2 kHz	5 kHz	8 kHz	10 kHz	16kHz
4,022	2 kHz	5 kHz	8 kHz	10 kHz	16kHz
4,030	2 kHz	5 kHz	8 kHz	10 kHz	16kHz
4,040	2 kHz	5 kHz	8 kHz	10 kHz	16kHz
4,055	2 kHz	5 kHz	8 kHz	10 kHz	16kHz
4,075	2 kHz	5 kHz	8 kHz	10 kHz	16kHz
4,110	2 kHz	5 kHz	8 kHz	10 kHz	16kHz
4,150	2 kHz	4 kHz	8 kHz	10 kHz	16kHz
4,185	2 kHz	4 kHz	8 kHz	10 kHz	16kHz
4,220	2 kHz	4 kHz	8 kHz	10 kHz	16kHz

P290 STC MOTOR PROT.

This parameter sets the protection technique against motor overheating.

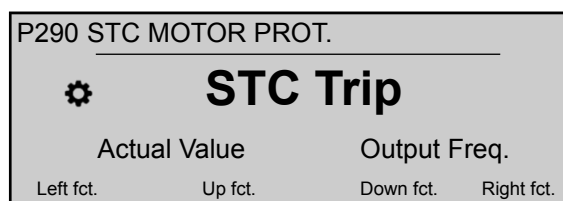

Possible settings are "Thermistor trip" or "STC trip" (default).

P291 STC MOTOR THERMAL

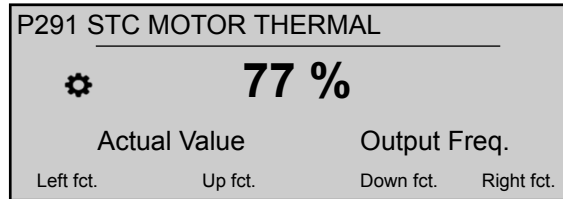

This parameter shows the calculated percentage of allowed maximum temperature (for the motor) calculated by STC, based on actual current and speed.

P295 CURR.LIM.FUNCT.

This parameter activates (ON) or deactivates (OFF, default) the current limit functionality.

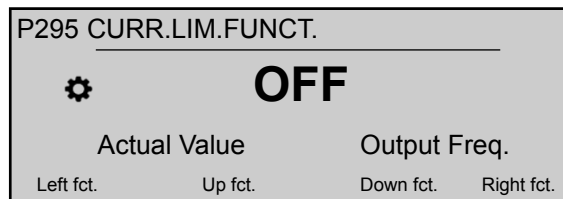

P296 CURR.LIMIT SET

This parameter (default value 110%, possible setting 10-300%) sets the current limit for motor (in % of rated motor current)

If the set value is higher than HYDROVAR maximum rated output, then current is still limited to the maximum rated output.

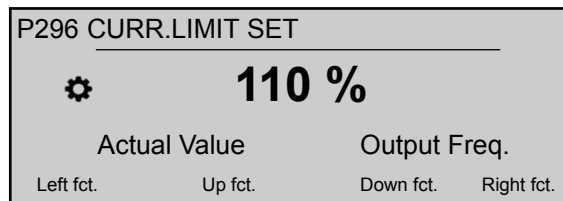

8.3.7 M300 REGULATION

MENU SCOPE

This submenu includes the following software parameters:

- Jog
- Window
- Hysteresis
- Regulation mode
- Lift settings

P305 JOG

This parameter deactivates the internal controller of HYDROVAR and changes to manual mode.

Display shows the following information:

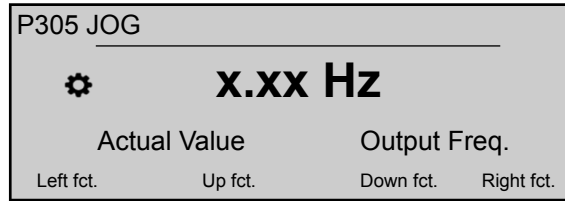

Where:

- **JOG:** is the parameter description
- **X.XX:** is the current parameter value (0Hz - P245 **MAX.FREQ.**); at 0.0 Hz, the unit stops.
- **Actual value:** is the input signal supplied by the selected transducer (set by submenu 400), expressed with the dimension unit set by parameter 405
- **Output frequency:** current frequency supplied by the drive to the motor
- Left/Up/Down/Right fct.: actual functions of the related push buttons

P310 WINDOW G

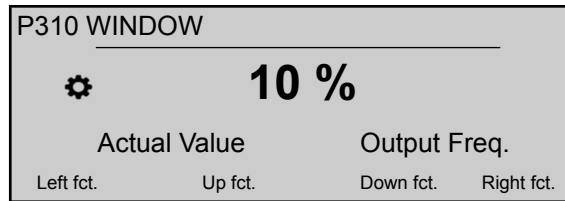

This parameter (default value 10%, possible setting 0-100%) sets the range for ramp control; from slow to fast.

P315 HYSTERESIS G

This parameter (default value 80%, possible setting 0-100%) sets the hysteresis for ramp switching. It determines where the normal regulation is done; value = 99% indicates an accurate control without automatic shut-off.

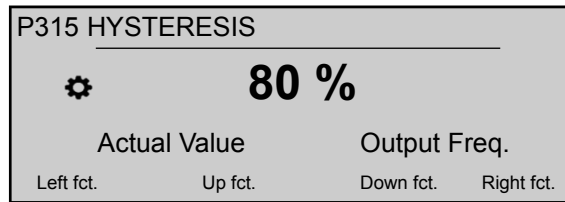

P320 REG.MODE G

This parameter selects the regulation mode.

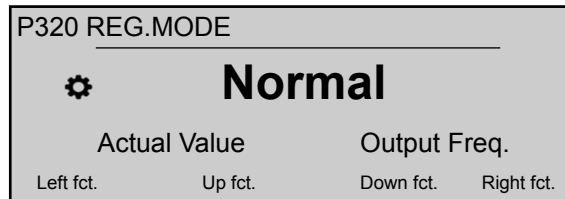

Possible setting are:

Setting	Description
Normal	Increased speed with falling actual value signal.

Setting	Description
Inverse	Reduced speed with falling actual value signal.

P325 FRQ.LIFT G

This parameter (default value 30.0 Hz, possible setting 0.0-70.0 Hz) sets the frequency limit for the required lift value where the required pressure starts to be increased.

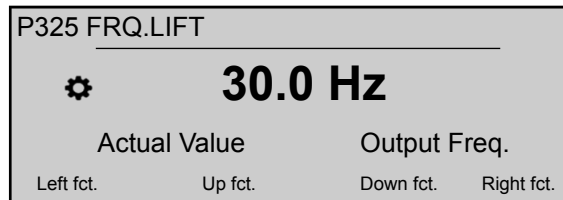

The correct frequency is when the pump reaches the set pressure at zero flow. This can be determined by using P305 JOG.

P330 LIFT AMOUNT G

This parameter (default value 0.0 %, possible setting 0.0-200.0%) sets the lift amount for the required lift value in HVAC systems or for compensation of friction losses in long pipe work.

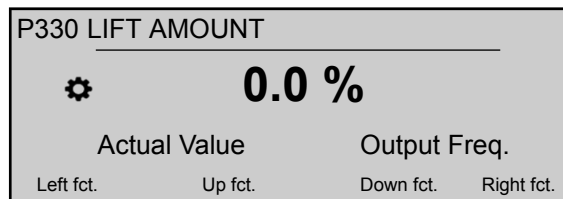

It determines the increase of the set value until the maximum speed (and maximum volume) is reached.

For an application example, see Example P330 LIFT AMOUNT.

8.3.8 M400 SENSOR

MENU SCOPE

In this submenu it is possible to configure all actual-value sensors that are connected to the HYDROVAR. However, the following limitations apply:

- It is possible to have maximum two transducers with current output or voltage-signal output.
- The transducer types: it is not possible to install two different transducer types because the main configuration is the same for all connected sensors.

This submenu includes the following software parameters:

- Dimension unit
- Configuration
- Type of sensor
- Sensor range
- Sensor curve
- Calibration

P405 DIMENSION UNIT

Selects the unit of measure for the system.

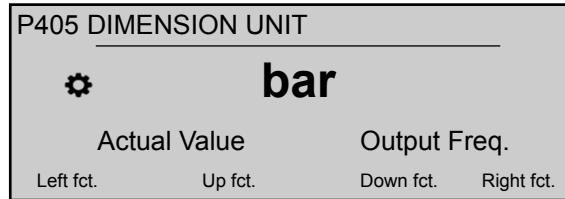

In case a change of this parameter is needed, consider to change P420 **SENSOR RANGE** to the corresponding dimension unit too!

P410 CONF.SENSOR

Sets how the connected sensors are used and which sensor is active.

It is also possible to measure the difference of two connected sensors or to configure an automatic switch-over in case of a faulty sensor.

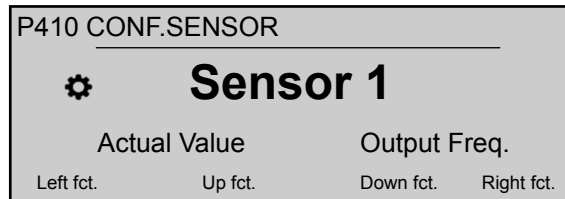

Possible settings are:

Table 13: Possible settings

Setting	Property	Description
Sensor 1	Constantly active	0/4 - 20 mA signal: connected to X1/2 and X1/1 (+24V)
		0/2 - 10 V signal: connected to X1/2, X1/1 (+24V) and X1/3 (GND)
Sensor 2	Constantly active	0/4 - 20 mA signal: connected to X1/5 and X1/4 (+24V)
		0/2 - 10 V signal: connected to X1/5, X1/4 (+24V) and X1/6 (GND)
Auto	Automatic switch over	In case of faulty sensor
Switch Dig1	Manual switching	Close digital input 1 (X1/14 - X1/15)
Switch Dig2	Manual switching	Close digital input 2 (X3/1 - X3/2, on Premium Card)
Switch Dig3	Manual switching	Close digital input 3 (X3/5 - GND)
Switch Dig4	Manual switching	Close digital input 4 (X3/15 - 16)
Auto Lower	Automatic switch over	The sensor with the lower actual value is active
Auto Higher	Automatic switch over	The sensor with the highest actual value is active
Sens.1 - Sens.2	-	The difference of the connected sensors as actual value

P415 SENSOR TYPE

Selects the sensor type and the input terminal.

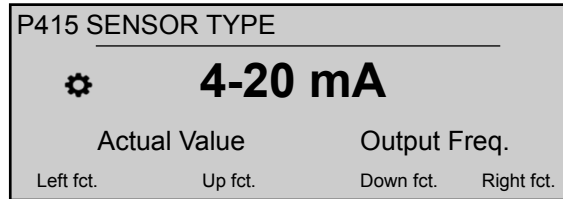

Possible settings are:

Table 14: Selection of the sensor type and input terminal

Setting	Input Terminals	Actual Value
<ul style="list-style-type: none"> Analog I 4 - 20 mA Analog I 0 - 20 mA 	<ul style="list-style-type: none"> X1/2: Sensor 1 X1/5: Sensor 2 	It is determined by a current signal connected to the given input terminal.
Analog U 0-10 V	<ul style="list-style-type: none"> X1/2: Sensor 1 X1/5: Sensor 2 	It is determined from a voltage signal connected to the given input terminal.

P420 SENSOR RANGE



Sets the end range value (20 mA or 10 V) of the connected sensor.

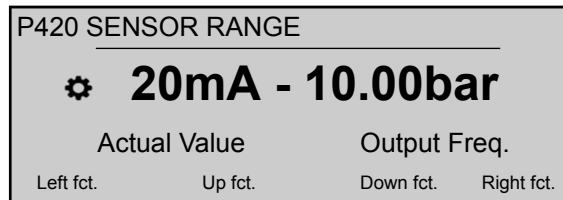

In particular, the end range value (20mA or 10V) shall be always equal to the 100% of the sensor range (i.e. for a 0.4bar differential pressure sensor, will be 20mA=0.4bar)

P425 SENSOR CURVE

Sets the mathematical function (curve) to determine the Actual Value based on the Sensor signal.

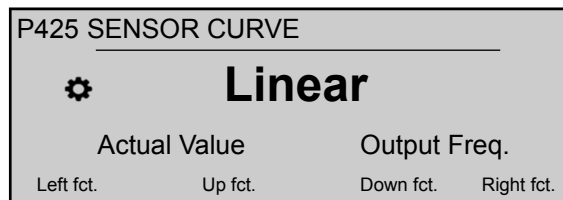

Possible settings are:

Setting	Application
Linear	<ul style="list-style-type: none"> Pressure control Differential Pressure control Level Temperature Flow control (inductive or mechanical)
Quadratic	<ul style="list-style-type: none"> Flow control (using an orifice plate with a differential pressure sensor)

P430 SENS.1 CAL.0

This parameter is used to calibrate the minimum value of Sensor 1.

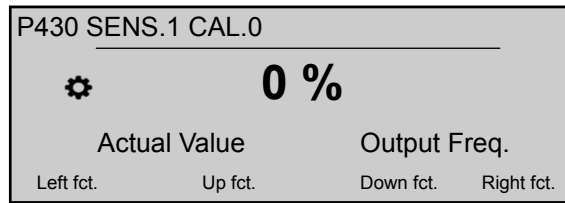

After setting P405 **DIMENSION UNIT** and P420 **SENSOR RANGE**, the zero point for this sensor can be adjusted between -10 % and +10 %.

P435 SENS.1 CAL.X

This parameter is used to calibrate the upper range value of sensor 1.

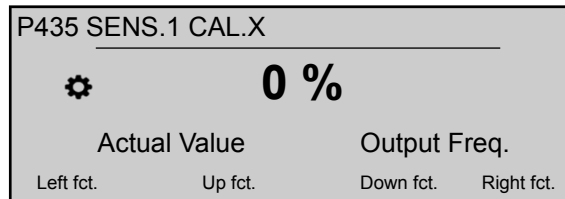

After setting P405 **DIMENSION UNIT** and P420 **SENSOR RANGE**, the upper range value can be adjusted between -10 and +10%.

P440 SENS.2 CAL.0

This parameter is used to calibrate the minimum value of Sensor 2.

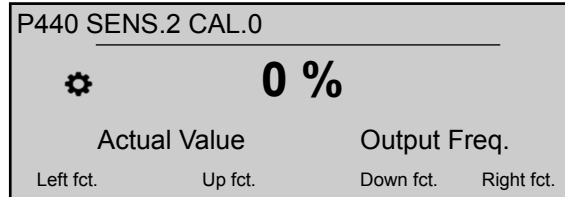

After setting P405 **DIMENSION UNIT** and P420 **SENSOR RANGE**, the zero point for this sensor can be adjusted between -10 % and +10 %.

P445 SENS.2 CAL.X

This parameter is used to calibrate the upper range value of sensor 2.

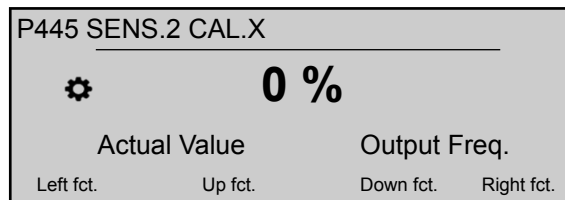

After setting P405 **DIMENSION UNIT** and P420 **SENSOR RANGE**, the upper range value can be adjusted between -10 and +10%.

8.3.9 M500 SEQUENCE CONTR.**MENU SCOPE**

In this submenu it is possible to configure parameters for running a multi-pump system. This submenu includes the following software parameters:

- Actual value (increase, decrease)
- Frequency (enable, disable, drop)
- Delay (enable, switch, disable)
- Overvalue
- Overvalue delay
- Switch intervals
- Synchronous frequency limit and window

For example and more information, see P500 [Example: P500 SUBMENU SEQUENCE CNTR.](#) (page 104).

P505 ACT.VAL.INC. G

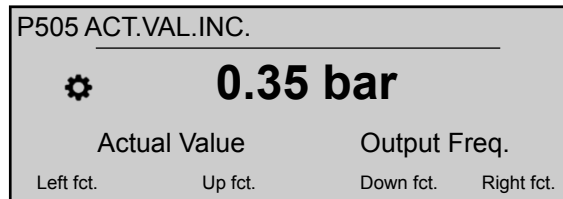

Sets the lift value on the range 0.00 - P420 **SENSOR RANGE**.

P510 ACT.VAL.DEC. G

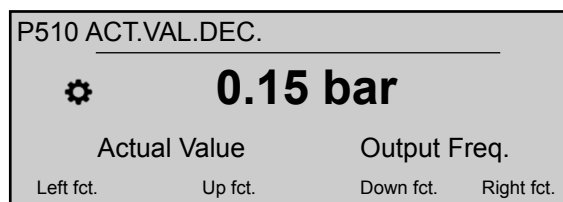

Sets the drop value on the range 0.00 - P420 **SENSOR RANGE**.

P515 ENABLE FRQ. G

This parameter (default value 48.0Hz, possible setting 0.0-70.0Hz) sets the desired release frequency for the following pumps.

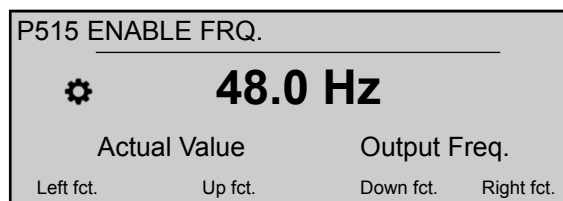

The next pump starts when this value is reached and the system pressure drops below the difference (P02 **REQUIRED VAL.** - P510 **ACT.VAL.DEC.**).

P520 ENABLE DLY.

This parameter only applies to cascade relay!

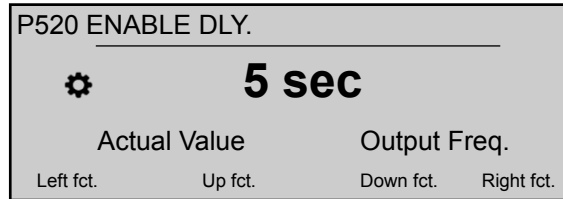

It sets the enable delay time: the fixed-speed pump starts after the selected time.

P525 SWITCH DLY.

This parameter only applies to cascade relay!



It sets the switch delay time, thus avoiding repeated switching caused by consumption variation.

P530 DISABLE FRQ.

This parameter only applies to cascade relay!

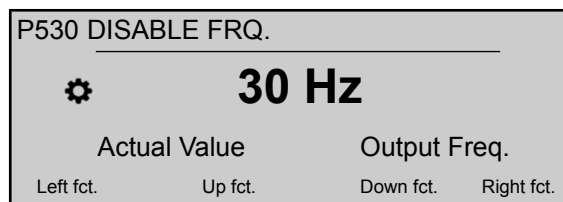

It sets the frequency to switch off the fixed speed pumps. If the MASTER Inverter goes below this frequency for longer time than the pre-selected P535 **DISABLE DLY.** and the system pressure is higher than P03 **EFF.REQ.VAL.**, the MASTER stops another assist pump.

P535 DISABLE DLY.

This parameter only applies to cascade relay!



It sets the delay time before switching off the assist pumps.

P540 DROP FRQ.

This parameter only applies to cascade relay!

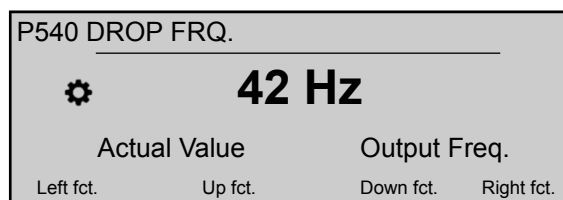

It is used to prevent the system from pressure hammers. Before the MASTER starts a new assist pump, it drops to this frequency and then (when the frequency is reached) the assist pump is started; at that point the MASTER Inverter returns to normal operation.

P545 OVERVALUE

This parameter only applies to cascade relay!

P545 OVERVALUE			
		OFF	
Actual Value		Output Freq.	
Left fct.	Up fct.	Down fct.	Right fct.

This parameter prevents the system against overpressure in case the HYDROVAR has been parameterized incorrectly: if this selected value is reached, an immediate shut-off of the follow-up-pumps is executed.

Possible settings are "Off" (default) or P420 **SENSOR RANGE**.

P550 OVERVAL.DLY.

This parameter only applies to cascade relay!

P550 OVERVAL.DLY.			
		0.0 sec	
Actual Value		Output Freq.	
Left fct.	Up fct.	Down fct.	Right fct.

This parameter sets the delay time to switch off an assist pump in case the actual value exceeds P545 **OVERVALUE** limit.

P555 SWITCH INTV. G

This parameter only applies to cascade serial and synchronous!

P555 SWITCH INTV.			
		24 hours	
Actual Value		Output Freq.	
Left fct.	Up fct.	Down fct.	Right fct.

This parameter sets the switch interval for the cyclic change-over: it allows an automatic change-over of the MASTER pump and the assist pumps.

As soon as the switch time is reached the next pump becomes MASTER and the counter restarts; this gives even wear and similar operating hours to all pumps. The switch interval is active as long as the MASTER does not stop.

For information about how to find the correct setting, see [Example: P500 SUBMENU SEQUENCE CNTR.](#) (page 104).

P560 SYNCHR.LIM. G

This parameter only applies to cascade synchronous!

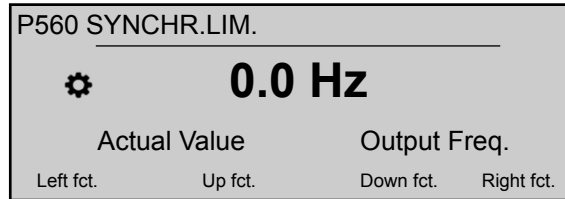

This parameter sets the frequency limit: the first assist pump shuts off if the frequency goes below this parameter's value.

For information about how to find the correct setting, see [Example: P500 SUBMENU SEQUENCE CNTR.](#) (page 104).

P565 SYNCHR.WND. G

This parameter only applies to cascade synchronous!

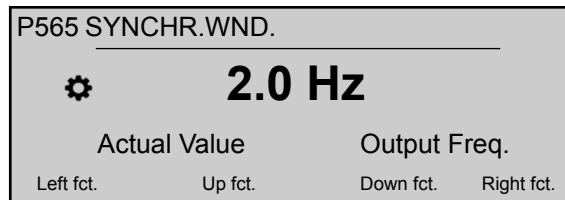

This parameter sets the frequency window: the limit for switching off the next assist pump.

For information about how to find the correct setting, see [Example: P500 SUBMENU SEQUENCE CNTR.](#) (page 104).

8.3.10 M600 ERROR

MENU SCOPE

This submenu includes the following software parameters:

- Minimum threshold limit
- Delay time
- Automatic error reset

P605 MIN.THRESH.

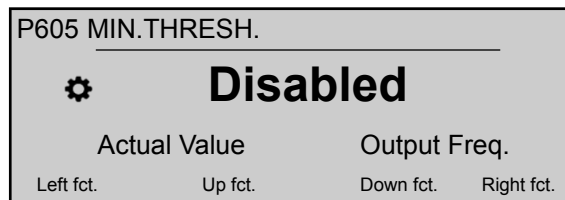

Selects the minimum threshold limit: if an adjusted value > 0.00 is not reached within the P610 **DELAY-TIME**, the unit stops (failure message: **MIN.THRESH.ERROR**).

P610 DELAY-TIME G

NOTICE:

The minimum threshold function is also active during the start-up of the pump. Therefore, the delay time must be set higher than the time required to start up the pump and fill the system.

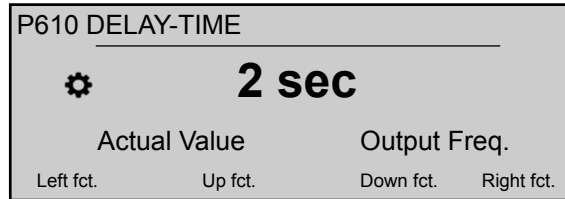

Selects the delay time of the minimum threshold limit: it shuts off the HYDROVAR if the actual value drops below P605 **MIN.THRESH.** or if a low-water protection (at terminals X1/16-17) becomes open.

P615 ERROR RESET

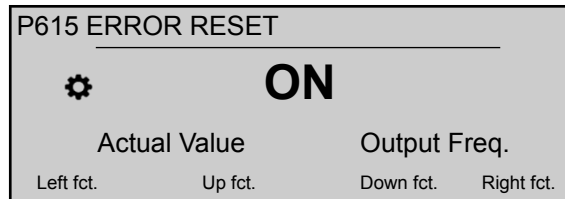

Selects automatic reset of errors; if a manual reset is selected, switch an external ON/OFF contactor to the terminal X1/18-19. Possible setting are:

Setting	Description
ON	<ul style="list-style-type: none"> Allows an automatic restart five times when an error occurs Shuts off the unit after the fifth restart. The internal counter is decreased by one after each operating hour.
OFF	<ul style="list-style-type: none"> Each error shown on the display. Each error must be reset manually.

8.3.11 M700 OUTPUTS

MENU SCOPE

This submenu includes the following software parameters:

- Analog output 1 and 2
- Configuration of status relay 1 and 2

P705 ANALOG OUT.1

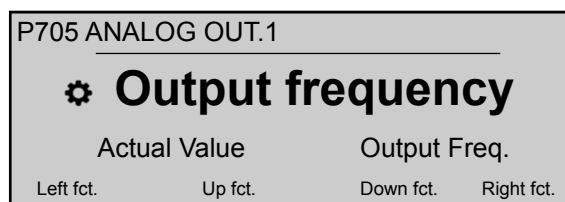

Selects the first analog output, which is connected to terminal X3/3-4 on the Premim Card (analogue output 0 - 10 V = 0 - 100%).

P710 ANALOG OUT.2

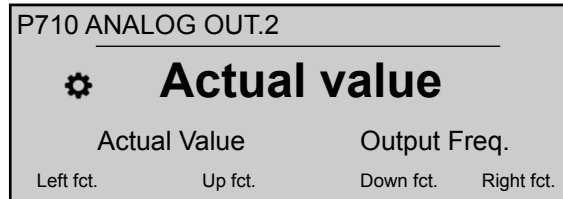

Selects the second analog output, which is connected to terminal X3/5-6 on the Premim Card (analog output 4 - 20 mA = 0 - 100%).

P715 CONF.REL.1

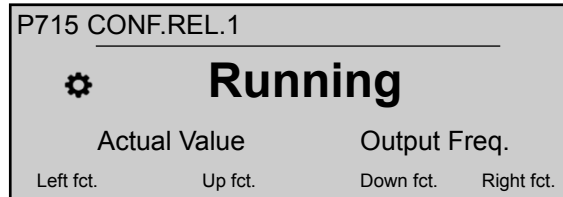

Selects the status relay 1 (X2/4 - 5 - 6). Possible settings are:

Setting	Description	Action if status = YES
Power	HYDROVAR is connected to the power supply.	Relay 1: X2/ 4 - 6 closed
Running	The motor is running	Relay 1: X2/ 4 - 6 closed
Errors	An error is indicated on HYDROVAR (including power failure).	Relay 1: X2/ 5 - 6 closed
Warnings	A warning is indicated in the HYDROVAR	Relay 1: X2/ 5 - 6 closed
StandBy	The pump is released manually and by external release, no error/warning is indicated and the HYDROVAR does not run.	Relay 1: X2/ 4 - 6 closed
Errorreset	If the parameter P615 ERROR RESET is activated and a warning occurs five times -> Error ->	Relay 1: X2/ 4 - 6 closed

P720 CONF.REL.2

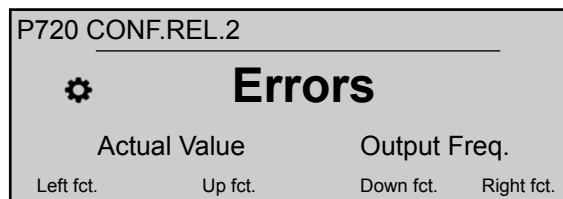

Selects the status relay 2 (X2/1 - 2 - 3). Possible settings are:

Setting	Description	Action if status = YES
Power	HYDROVAR is connected to the power supply.	Relay 2: X2/ 1 - 3 closed
Running	The motor is running	Relay 2: X2/ 1 - 3 closed
Errors	An error is indicated on HYDROVAR (including power failure).	Relay 2: X2/ 2 - 3 closed

Setting	Description	Action if status = YES
Warnings	A warning is indicated in the HYDROVAR	Relay 2: X2/ 2 - 3 closed
StandBy	The pump is released manually and by external release, no error/warning is indicated and the HYDROVAR does not run.	Relay 2: X2/ 1 - 3 closed
Errorreset	If the parameter P615 ERROR RESET is activated and a warning occurs five times - > Error - >	Relay 2: X2/ 1 - 3 closed

8.3.12 M800 REQUIRED VALUES

MENU SCOPE

This submenu includes the following software parameters:

- Configuration of the required value
- Switching between required values
- Required frequencies for Actuator mode

For an example, see [Example: P105 ACTUATOR mode](#) (page 102).

P805 C.REQ.VAL.1

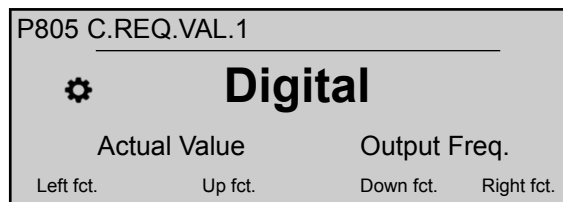

Configures the required value 1. Possible setting are:

Setting	Description	Connected to terminals (Premium Card)
Digital	The internal required value 1 is used. For setting, see P02 REQUIRED VAL. or P820 REQ.VAL.1	-
Analog U 0-10V	The required value 1 is set by the value of voltage signal.	X3/8-9
Analog I 0-20mA	The required value 1 is set by the value of current signal.	X3/7-8
Analog I 4-20mA	The required value 1 is set by the value of current signal.	X3/7-8

P810 C.REQ.VAL.2

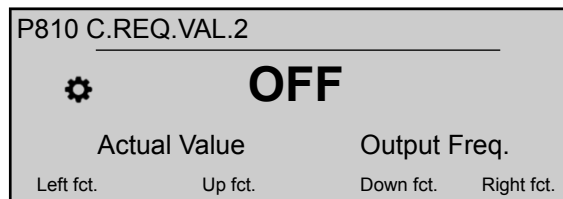

Configures the required value 2. Possible settings are:

Setting	Description	Connected to terminals (Premium Card)
Off	Required value 2 not used.	-
Digital	The internal required value 2 is used. For setting, see P02 REQUIRED VAL. or P825 REQ.VAL.2	-
Analog U 0-10V	The required value 2 is set by the value of voltage signal.	X3/11-12
Analog I 0-20mA	The required value 2 is set by the value of current signal.	X3/10-11
Analog I 4-20mA	The required value 2 is set by the value of current signal.	X3/10-11

P815 SW.REQ.VAL.

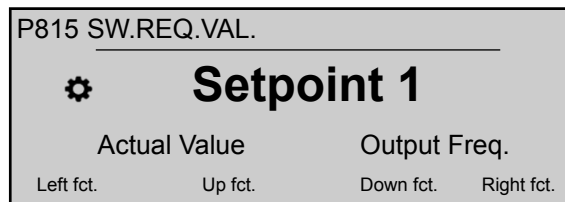

Configure the switching between required value 1 and 2. Possible setting are:

Setting	Switching possibilities	Action
Setpoint 1	No	Only required value 1 is active
Setpoint 2	No	Only required value 2 is active
Switch Dig 1	Manual	Close digital input 1 (X1/14-15)
Switch Dig 2	Manual	Close digital input 2 (X3/1-2) on Premium Card

P820 REQ.VAL.1

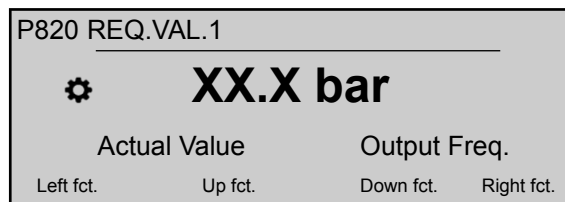

Sets the digital required value 1 in bar (possible setting 0.0 - P420 **SENSOR RANGE**).

The value is active in all operation mode (but not Actuator mode), if the following applies:

- P805 **C.REQ.VAL.1** is set to **Digital**.
- P815 **SW.REQ.VAL.** is set to **Setpoint 1** or the **REQUIRED VALUE 1** is selected via digital input (open).

If the current required value is active, P02 **REQUIRED VAL.** can override the pre-selected required value.

P825 REQ.VAL.2

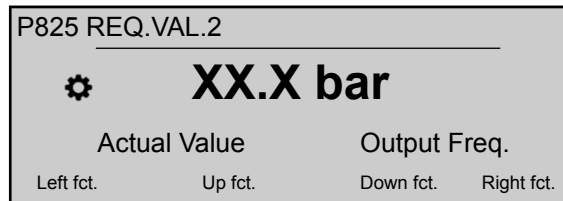

Sets the digital required value 2 in bar (possible setting 0.0 - P420 **SENSOR RANGE**).

The value is active in all operation mode (but not Actuator mode), if the following applies:

- P810 **C.REQ.VAL.2** is set to **Digital**.
- P815 **SW.REQ.VAL.** is set to **Setpoint 1** or the REQUIRED VALUE 2 is selected via digital input (open).

If the current required value is active, P02 **REQUIRED VAL.** can override the pre-selected required value.

P830 ACTUAT.FRQ1

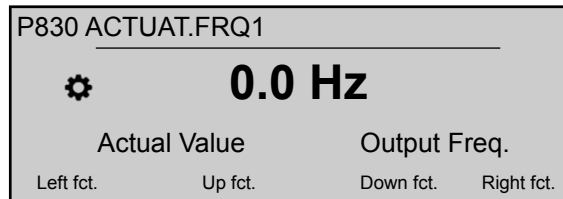

Set the required frequency 1 for Actuator mode (possible setting 0.0 Hz - P245 **MAX.FREQ.**).

The selected frequency is only active in Actuator mode, if the following applies:

- P805 **C.REQ.VAL.1** is set to **Digital**.
- P815 **SW.REQ.VAL.** is set to **Setpoint 1** or the ACTUATOR FREQUENCY 1 is selected via digital input (open).

P835 ACTUAT.FRQ2

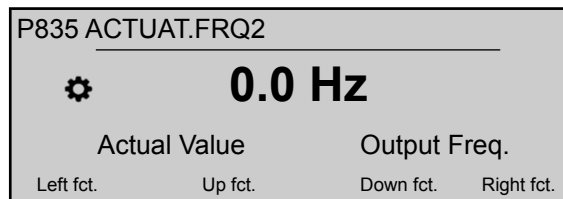

Set the required frequency 2 for Actuator mode (possible setting 0.0 Hz - P245 **MAX.FREQ.**).

The selected frequency is only active in Actuator mode, if the following applies:

- P810 **C.REQ.VAL.2** is set to **Digital**
- P815 **SW.REQ.VAL.** is set to **Setpoint 2** or the ACTUATOR FREQUENCY 2 is selected via digital input (closed).

8.3.13 M900 OFFSET

Menu scope

This submenu includes the following software parameters:

- Offset (input, range)
- Level (1, 2)

- Offset (X1, Y1)
- Offset (X2, Y2)

For an example of the offset function and more information, see [Example: P900 SUBMENU OFFSET](#) (page 105).

P905 OFFS.INPUT

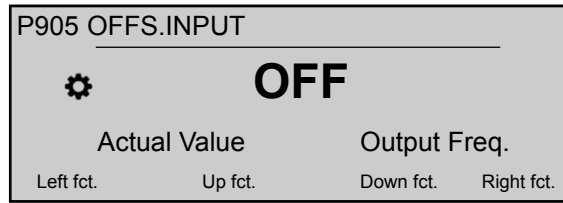

Selects the offset input. Possible setting are:

Setting	Offset calculation
Off	Disabled
An. U1 0-10V	Calculated from the voltage signal (0 - 10 V) connected to the terminals X3/7-8-9 (Required Value 1)
An. U2 0-10V	Calculated from the voltage signal (0 - 10 V) connected to the terminals X3/10-11-12 (Required Value 2)
An. I1 0-20mA	Calculated from the current signal (0 - 20 mA) connected to the terminals X3/7-8 (Required Value 1)
An. I1 4-20mA	Calculated from the current signal (4 - 20 mA) connected to the terminals X3/7-8 (Required Value 1)
An. I2 0-20mA	Calculated from the current signal (0 - 20 mA) connected to the terminals X3/10-11 (Required Value 2)
An. I2 4-20mA	Calculated from the current signal (4 - 20 mA) connected to the terminals X3/10-11 (Required Value 2)

If the incoming current signal drops to below 4 mA, a warning message is shown on the display; however, HYDROVAR continues to operate without the offset function.

P907 OFFSET RANGE

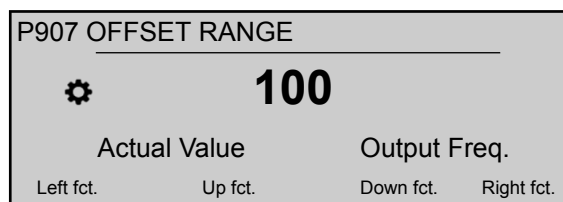

Set the representation of the sensor range: the value depends on the maximum range of the connected offset sensor. A higher offset range gives a higher signal input resolution.

For an example of the offset function and more information, see [Example: P900 SUBMENU OFFSET](#) (page 105).

P910 LEVEL 1

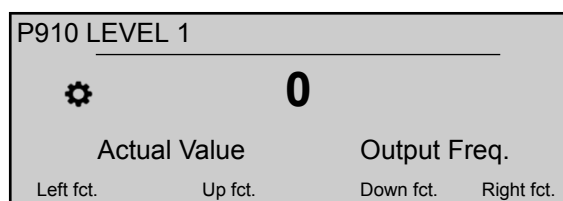

Selects the first level until the offset function 1 is active.

For an example of the offset function and more information, see [Example: P900 SUBMENU OFFSET](#) (page 105).

P912 OFFSET X1

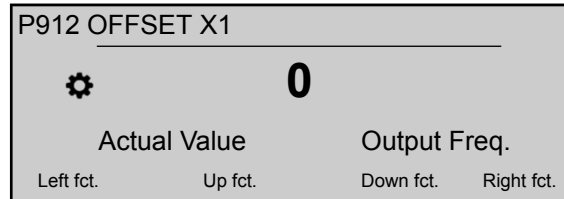

Sets the offset signal value (X1), which is a fixed point.

For an example of the offset function and more information, see [Example: P900 SUBMENU OFFSET](#) (page 105).

P913 OFFSET Y1

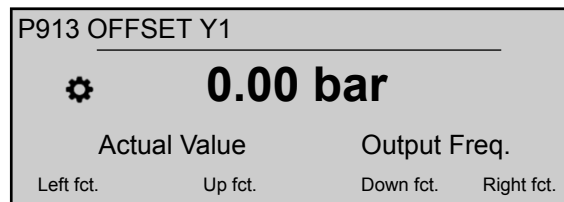

Set the maximum allowed pressure at P912 **OFFSET X1**.

For an example of the offset function and more information, see [Example: P900 SUBMENU OFFSET](#) (page 105).

P915 LEVEL 2

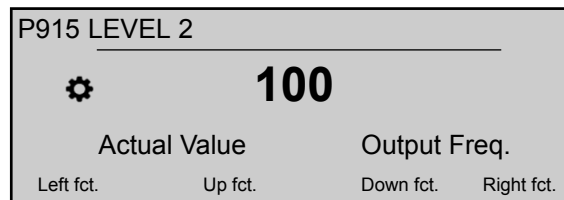

Selects the second limit where the offset function 2 starts to be active.

For an example of the offset function and more information, see [Example: P900 SUBMENU OFFSET](#) (page 105).

P917 OFFSET X2

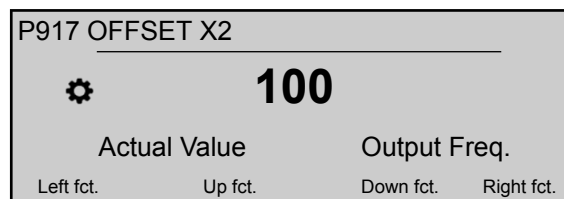

Sets the offset signal value (X2), which is a fixed point.

For an example of the offset function and more information, see [Example: P900 SUBMENU OFFSET](#) (page 105).

P918 OFFSET Y2

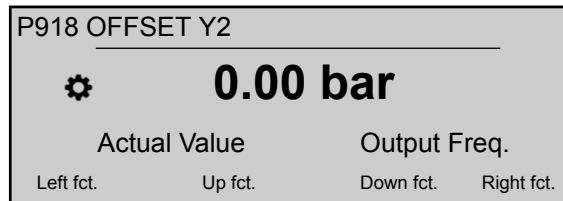

Set the required pressure at this flow rate.

For an example of the offset function and more information, see [Example: P900 SUBMENU OFFSET](#) (page 105).

8.3.14 M1000 TEST RUN

Menu scope

This submenu includes the following software parameters:

- Automatic test run
- Test run frequency
- Test run boost
- Test run time
- Selecting Inverter for test run
- Manual test run

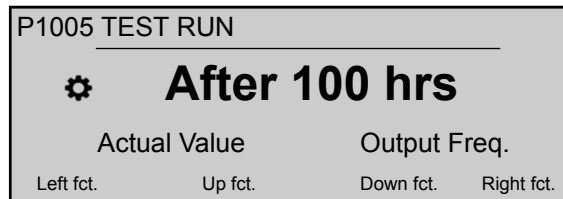
P1005 TEST RUN G

Controls the automatic test run, which starts up the pump after the last stop, to prevent the pump from blocking (possible settings are "Off" or "After 100 hrs").

Automatic test run is only active when both of the following occur:

- HYDROVAR is stopped but manually released.
- The external ON/OFF contact (X1/18 - 19) is closed.

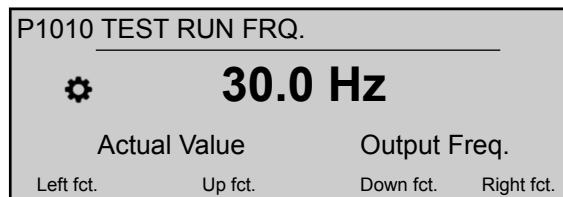
P1010 TEST RUN FRQ. G

Sets the frequency for manual and automatic test run.

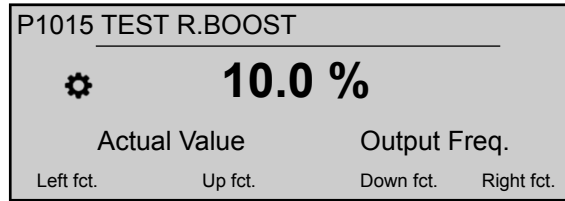
P1015 TEST R.BOOST G

Sets the motor starting voltage (possible setting 0 -25%) as a percentage of the rated input voltage.

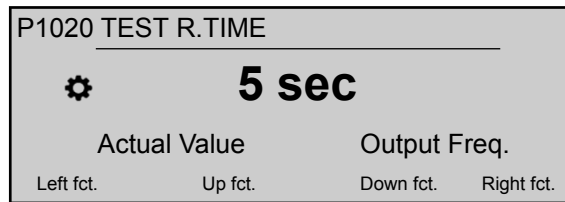
P1020 TEST R.TIME G

Sets the time for the test run.

P1025 SEL.DEVICE

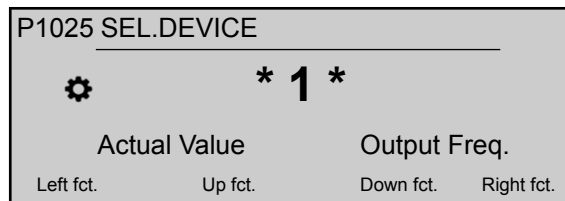

Selects the inverter for the manual test run.

P1030 TEST RUN MAN.

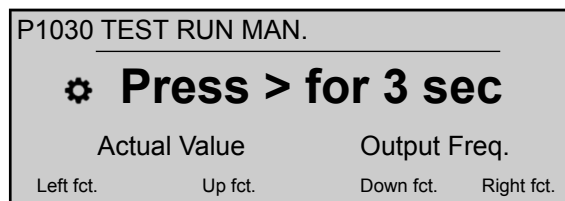

Performs a manual test run for the unit selected by P1025 **SEL.DEVICE**: this function is also valid for fixed-speed pumps in Cascade relay mode.

For this parameter please note that, once entered into edit mode (by pressing the provided push button), the user can confirm the new value by pressing for 3 sec the right (▶) push button.

8.3.15 M1100 SETUP

MENU SCOPE

This submenu includes the following software parameters:

- Restore factory setting
- Password 2
- Clear error memory

- Clear motor hours
- Clear operation time

P1110 FACTORY SET

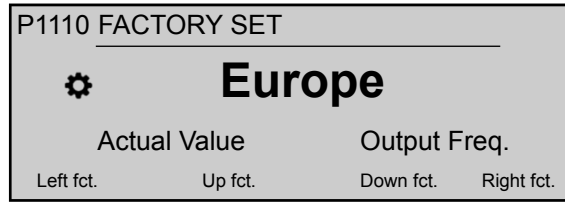

Restores the factory settings. Possible settings are:

Setting	Offset calculation
Europe	Restore the factory setting for European versions.
USA	Restore the factory setting for US versions.

For this parameter please note that, once entered into edit mode (by pressing the provided push button), the user can confirm the new value by pressing for 3 sec the right (▶) push button.

P1120 PASSWORD 2

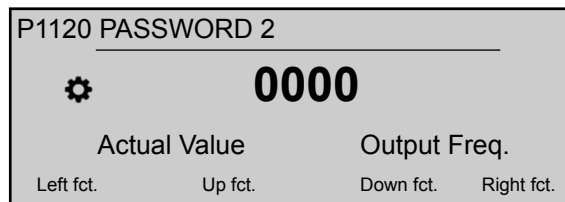

Enter the system password, which gives access to factory parameters.

For this parameter please note that, once entered into edit mode (by pressing the provided push button), the user can confirm the new value by pressing for 3 sec the right (▶) push button.

P1125 CLR.ERRORS

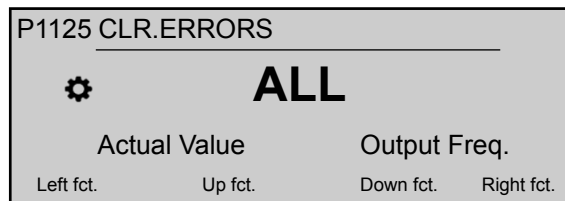

Used to clear the error memory either (1-8) for one specific unit or ALL for all units in Cascade Serial or Synchronous.

For this parameter please note that, once entered into edit mode (by pressing the provided push button), the user can confirm the new value by pressing for 3 sec the right (▶) push button.

P1130 CLR.MOTOR H.

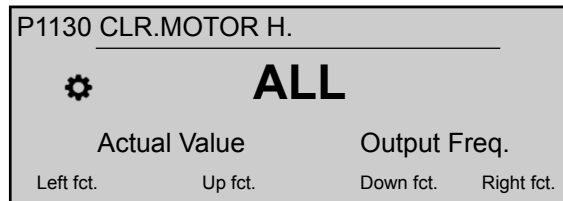

Used to clear the motor hours either (1-8) for one specific unit or ALL for all units in Cascade Serial or Synchronous.

For this parameter please note that, once entered into edit mode (by pressing the provided push button), the user can confirm the new value by pressing for 3 sec the right (▶) push button.

P1135 CLR.OPERAT.

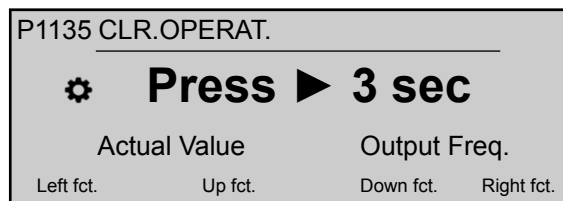

Clear the operation time, which stores the total time the HYDROVAR is connected to power supply.

For this parameter please note that, once entered into edit mode (by pressing the provided push button), the user can confirm the new value by pressing for 3 sec the right (▶) push button.

P1140 CLR.KWH CNT.

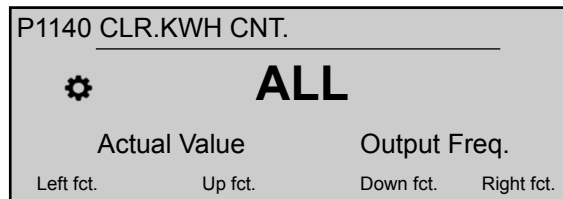

Used to clear the kilowatt-hours counter either (1-8) for one specific unit or ALL for all units in Cascade Serial or Synchronous.

For this parameter please note that, once entered into edit mode (by pressing the provided push button), the user can confirm the new value by pressing for 3 sec the right (▶) push button.

8.3.16 M1200 RS-485 INTERFACE

MENU SCOPE

This submenu includes the following software parameters:

- User interface (address, baudrate, format)
- Internal interface (pump address)

The following parameters are necessary for the communication between HYDROVAR and an external device (e.g. PLC) via standardized Modbus-protocol. Set desired address, Baudrate and Format according the system requirements.

P1203 PROTOCOL

P1203 PROTOCOL			
		Modbus RTU	
Actual Value		Output Freq.	
Left fct.	Up fct.	Down fct.	Right fct.

Sets the desired communication protocol.

Possible settings are:

- Disabled
- Modbus RTU
- Modbus ASCII
- BACNet MS/TP

P1205 ADDRESS

P1205 ADDRESS			
		1	
Actual Value		Output Freq.	
Left fct.	Up fct.	Down fct.	Right fct.

Sets the desired address (possible setting 1 - 247) for the user interface.

P1210 BAUD RATE

P1210 BAUD RATE			
		9600	
Actual Value		Output Freq.	
Left fct.	Up fct.	Down fct.	Right fct.

Set the **BAUD RATE** for the user interface.

Possible settings are:

- 1200
- 2400
- 4800
- 9600
- 14400
- 19200
- 38400
- 57600
- 76800
- 115200

P1215 FORMAT

P1215 FORMAT			
		8, N, 1	
Actual Value		Output Freq.	
Left fct.	Up fct.	Down fct.	Right fct.

Set the data **FORMAT** for the communication port, depending on the value of P1203 **PROTOCOL**

Possible settings are:

- 8, E, 1
- 8, O, 1
- 8, N, 2
- 8, N, 1
- 7, E, 1
- 7, O, 1
- 7, N, 2
- 7, N, 1

P1220 PUMP ADDR.

P1220 PUMP ADDR.			
		1	
Actual Value		Output Freq.	
Left fct.	Up fct.	Down fct.	Right fct.

Selects an address for each inverter.

P1221 BACNET DEV. ID

P1221 BACNET DEV.ID			
		84001	
Actual Value		Output Freq.	
Left fct.	Up fct.	Down fct.	Right fct.

Sets Bacnet Device Object ID

P1225 SSID NUMBER

P1225 SSID NUMBER			
		01234567	
Actual Value		Output Freq.	
Left fct.	Up fct.	Down fct.	Right fct.

This parameter shows the identification number of the Wi-Fi network generated when the wireless module is assembled into HYDROVAR.

In particular, the network name will be: "hydrovar__P1225__", where P1225 is the value of this parameter, expressed as an 8 character word.

Example: if P1225 = a1b2c3d4, wifi network name = "hydrovara1b2c3d4"

P1226 SEC.KEY NUMBER

P1226 SEC.KEY NUMBER			
		01234567	
Actual Value		Output Freq.	
Left fct.	Up fct.	Down fct.	Right fct.

This parameter shows the security key number to access the Wi-Fi network generated when the wireless module is assembled into HYDROVAR.

In particular, the security key number will be: "xylem__P1226__", where P1226 is the value of this parameter, expressed as an 8 character word.

Example: if P1226 = b5c6d7e8, security key number = "xylemb5c6d7e8"

8.3.17 M1300 START-UP

MENU SCOPE

This submenu includes all the parameters necessary for a quick start-up of HYDROVAR:

- Language
- Motor Configuration (Power, Voltage, ...)
- Single/Multi Pump configuration
- Required Value

P1301 LANGUAGE

P1301 LANGUAGE			
		English	
Actual Value		Output Freq.	
Left fct.	Up fct.	Down fct.	Right fct.

This parameter selects the display language.

P1302 MOTOR NOM.POWER

P1302 MOTOR NOM.POWER			
		1.5 kW	
Actual Value		Output Freq.	
Left fct.	Up fct.	Down fct.	Right fct.

This parameter set the nominal power of the motor coupled with HYDROVAR, as reported on the motor nameplate. For possible setting, see [P265 MOTOR NOM.POWER](#) (page 63)

P1303 MOTOR NOM.VOLT.

P1303 MOTOR NOM.VOLT.			
		230 V	
Actual Value		Output Freq.	
Left fct.	Up fct.	Down fct.	Right fct.

Sets the motor nominal voltage, as reported in the motor nameplate, according to

- the chosen motor connection
- the output voltage of the HYDROVAR

For possible setting, see [P266 MOTOR NOM.VOLT.](#) (page 63)

P1304 PRE-SET MOTOR ?

P1304 PRE-SET MOTOR ?			
 YES			
Actual Value		Output Freq.	
Left fct.	Up fct.	Down fct.	Right fct.

By selecting "Yes", the user is declaring the use of a Lowara IE3 surface 2-poles motor 50Hz (without Motor Filter): in this case, the motor's electrical parameters are already available to HYDROVAR, so the start-up procedure skips to P1308 **STC MOTOR PROT..**

By selecting "NO", the user is declaring the use of any other motor: in this case the motor's electrical parameters need to be set into HYDROVAR, so the start-up procedure goes to the next step (P1305 **MOTOR NOM.CURR.**)

P1305 MOTOR NOM.CURR.

P1305 MOTOR NOM.CURR.			
 7.5 A			
Actual Value		Output Freq.	
Left fct.	Up fct.	Down fct.	Right fct.

Sets the motor nominal current, as reported in the motor nameplate, according to

- the chosen motor connection
- the output voltage of the HYDROVAR

P1306 MOTOR NOM.SPEED

P1306 MOTOR NOM.SPEED			
 3000 rpm			
Actual Value		Output Freq.	
Left fct.	Up fct.	Down fct.	Right fct.

Sets the motor nominal speed, as reported in the motor nameplate.

P1307 AMPI

P1307 AMPI			
 Full			
Actual Value		Output Freq.	
Left fct.	Up fct.	Down fct.	Right fct.

This parameter activates the Automatic Motor Parameter Identification; possible settings are "Off" (AMPI not active), "Full" or "Reduced" (procedure to be performed only in case LC filters are applied on the motor cable).

For this parameter please note that, once entered into edit mode (by pressing the provided push button), the user can confirm the new value by pressing for 3 sec the right (▶) push button.

For further information, see [P275 AMPI](#) (page 65)

P1308 STC MOTOR PROT.

P1308 STC MOTOR PROT.			
 STC Trip			
Actual Value		Output Freq.	
Left fct.	Up fct.	Down fct.	Right fct.

This parameter sets the protection technique against motor overheating; possible the settings are "Thermistor trip" or "STC trip" (default).

P1309 MODE

P1309 MODE			
 Controller			
Actual Value		Output Freq.	
Left fct.	Up fct.	Down fct.	Right fct.

This parameter selects which operating mode to set the unit to.

For possible setting, see [P105 MODE](#) (page 55).

P1310 PUMP ADDR.

P1310 PUMP ADDR.			
 1			
Actual Value		Output Freq.	
Left fct.	Up fct.	Down fct.	Right fct.

This parameter selects an address (1-8) for each HYDROVAR. If several MASTER inverters are connected via the internal RS-485 connection (maximum eight in Cascade serial mode), then the following must apply:

- Each HYDROVAR needs an individual pump-address (1-8)
- Each address can only be used once.

P1311 CONTROL MODE

P1311 CONTROL MODE			
 Constant			
Actual Value		Output Freq.	
Left fct.	Up fct.	Down fct.	Right fct.

For this parameter please note that, once entered into edit mode (by pressing the provided push button), the user can confirm the new value by pressing for 3 sec the right (▶) push button.

This parameter sets the pressure control mode for the pump system (single and multi pump): depending on the setting ("Constant" or "Differential") a set of further parameters are automatically configured.

Whenever P1311 **CONTROL MODE** is set to a new value, each parameter in the below table is overwritten to its own specified value, regardless of previous different settings.

	P1311 = Constant	P1311 = Differential
P225 RAMP 3	70 sec	90 sec
P230 RAMP 4	70 sec	90 sec
P250 MIN.FREQ.	20 Hz	25 Hz
P255 CONF.FMIN	f-> 0	f-> fmin
P260 FMIN TIME	0 sec	3 sec
P315 HYSTERESIS	80%	90%
P410CONF.SENSOR	Sensor 1	Sens.1 - Sens.2

P1312 DIMENSION UNIT

Selects the unit of measure for the system.

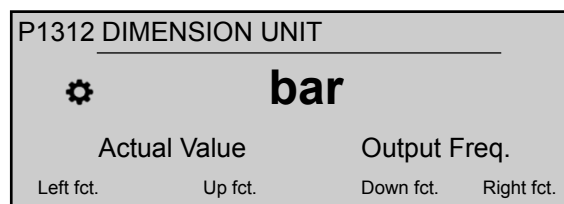

For further information, see [P405 DIMENSION UNIT](#) (page 71)

P1313 START-UP COMPLETED?

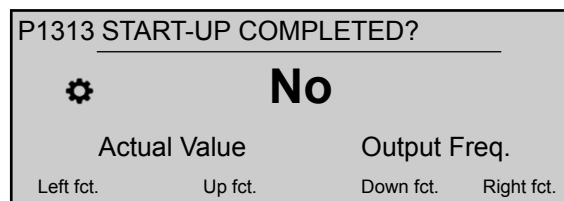

If the application the is a multi-pump, then the startup procedure for the first [N-1] pumps is stopped here when selecting Yes.

If the application the is a single-pump or the last pump of a Multi-pump, then select No .

P1314 SENSOR RANGE

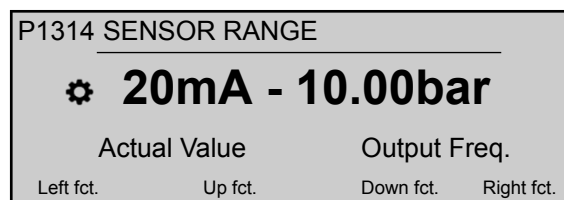

Sets the end range value (20 mA or 10 V) of the connected sensor. In particular, the end range value (20 mA or 10 V) must be always equal to the 100% of the sensor range (that is, for a 0.4 bar differential pressure sensor, is 20 mA=0.4 bar).

P1315 REQUIRED VAL.

P1315 REQUIRED VAL.			
 XXXXX bar			
Actual Value		Output Freq.	
Left fct.	Up fct.	Down fct.	Right fct.

For further information, see [P02 REQUIRED VAL.](#) (page 46).

P1316 START VALUE

P1316 START VALUE			
 100 %			
Actual Value		Output Freq.	
Left fct.	Up fct.	Down fct.	Right fct.

Sets the end range value (20 mA or 10 V) of the connected sensor. In particular, the end range. This parameter defines, in percentage (0-100%) of the required value (P1314 **REQUIRED VAL.**), the start value after pump stops.

If P1315 **REQUIRED VAL.** is met and there is no more consumption, then the pump stops. The pump starts again when the pressure drops below P04 **START VALUE.** Value 100% makes this parameter not effective (100%=off)!

P1317 MIN.THRESH.

P1317 MIN.THRESH.			
 Disabled			
Actual Value		Output Freq.	
Left fct.	Up fct.	Down fct.	Right fct.

Selects the minimum threshold limit: if an adjusted value > 0.00 is not reached within the P1317 **DELAY-TIME**, then the unit stops (failure message: MIN.THRESH.ERROR).

P1318 DELAY-TIME

P1318 DELAY-TIME			
 2 sec			
Actual Value		Output Freq.	
Left fct.	Up fct.	Down fct.	Right fct.

Selects the delay time of the minimum threshold limit: it shuts off the HYDROVAR if the actual value drops below P1317 **MIN.THRESH.** or if a low-water protection (at terminals X1/16-17) becomes open.

P1319 DATE

P1319 DATE			
 XX.XX.20XX			
Actual Value		Output Freq.	
Left fct.	Up fct.	Down fct.	Right fct.

Using this parameter current date can be set.

P1320 TIME

P1320 TIME			
 HH.MM			
Actual Value		Output Freq.	
Left fct.	Up fct.	Down fct.	Right fct.

Using this parameter current time can be set.

P1321 AUTO-START

P1321 AUTO-START			
 ON			
Actual Value		Output Freq.	
Left fct.	Up fct.	Down fct.	Right fct.

If **AUTO-START** = ON, then the HYDROVAR starts automatically (in case of demand) after reconnection of power following disconnection.

P1322 START-UP COMPLETED?

P1322 START-UP COMPLETED?			
 No			
Actual Value		Output Freq.	
Left fct.	Up fct.	Down fct.	Right fct.

If the user configured the whole application by selecting "YES" then the HYDROVAR will not make available the Start-up menu at every power-on.

By selecting "NO" at next power-on, the HYDROVAR will offer to the user the start-up procedure.

P1323 ADDRESS

P1323 ADDRESS			
 1			
Actual Value		Output Freq.	
Left fct.	Up fct.	Down fct.	Right fct.

Sets the desired address (possible setting 1 - 247) for the user interface.

9 Maintenance

9.1 General



Electrical Hazard:

Before any service or maintenance disconnect the system from the power supply and wait at least 5 minutes before starting work on or in the unit (the capacitors in the intermediate circuit are discharged by the internal discharge resistors).

The unit does not require any special maintenance.

Check list

- Make sure that the cooling fan and the vents are free from dust.
- Make sure that the ambient temperature is correct according to the limits of the unit.
- Make sure that qualified personal perform all modifications of the unit.
- Make sure that the unit is disconnected from the power supply before any work is carried out. Always consider the pump- and motor-instruction.

For further information, contact the local distributor.

9.2 Check error codes

Check the error codes in parameters P26 - P30 on a regular basis.

For more information about the parameters, see [P26 thru P30: ERROR memory](#) (page 52).

For detailed information about the error codes, see [Warnings and errors](#) (page 99).

9.3 Check the functions and parameters

If the hydraulic system is changed then follow this procedure.

1. Make sure that all functions and parameters are correct.
2. Adjust the functions and parameters if necessary.

10 Troubleshooting

Precaution

NOTICE:

- Always disconnect the unit from the power supply before you perform any installation and maintenance tasks.

Warnings and errors

- Warnings and errors are shown on the display and/or by the red LED.
- When a warning is active and the cause is not remedied within 20 seconds, then an error is shown and the unit stops. For some warnings, the unit keeps running depending on the type of error.
- When an error is active, the connected motor is stopped immediately. All errors are shown in plain text and saved in the error memory including date and time when the error appeared.
- An automatic error-reset can be activated in P600 **SUBMENU ERRORS** to reset an occurred error automatically five times. For more information about this function, see P615 **ERROR RESET**.
- All error signals and warnings can be indicated via the two status-relays on terminals X2/1-3 or X2/4-6 depending on the configuration. For more information, see P715 **CONF REL 1** and P720 **CONF REL 2**.

The errors can be reset automatically (depending on the setting in parameter P615 **ERROR RESET**) or manually in the following ways:

- Disable the power supply for more than 60 seconds.
- Press ◀ and ▶ simultaneously for 5 seconds.
- Open and close the external ON/OFF (X1/18-19).

10.1 No error message on the display

Error	Cause	Remedy
No AUTO-START after the power failure.	Parameter P08 AUTO-START is set to OFF .	Check parameter P08 AUTO-START .
The system pressure is not steady.	Pressure higher than the START VALUE or REG. MODE has been changed to Inverse .	Check parameter P04 START VALUE and/or P320 REG. MODE .

10.2 Error message on the display

Error	Cause	Remedy
OVERCURRENT ERROR 11	Power limit exceeded - too high motor current (fast rise detected).	<p>Check the following:</p> <ul style="list-style-type: none"> • The connection terminals of the unit • The connection terminals of the motor and the motor cable • The winding of the motor <p>Make sure all the connections, cables, and windings are OK and reset the error by disabling the power for more than 60 seconds.</p>

The automatic error-reset is not available for this failure so the power supply has to be cut for more than 60 seconds to reset the error.

Error	Cause	Check the following:
OVERLOAD ERROR 12	Power limit exceeded - motor current too high (slow rise detected).	<ul style="list-style-type: none"> Is the parameter P215/P220 RAMP 1/RAMP 2 too short and P265 BOOST too low? Do the cables and connection work? Is the pump is blocked? Does the motor rotate in the wrong direction before running (non-return valve defect)? Not allowed operation point or P245 MAX.FREQ. is too high, also check the P265 BOOST value.
OVERVOLTAGE ERROR 13	The voltage is too high.	<ul style="list-style-type: none"> Is the parameter P220 RAMP 2 too fast? Is the power supply too high? Are the voltage peaks too high? <p>If the error is power or voltage-related, line filters, line inductors, or RC-elements can be installed to resolve the issue.</p>
INVERT. OVERHEAT ERROR 14	The temperature inside the unit is too high.	<ul style="list-style-type: none"> Is the unit properly cooled? Are the units motor vents contaminated? Is the ambient temperature too high?
THERMO MOT/EXT ERROR 15	The PTC sensor has reached its release temperature.	<ul style="list-style-type: none"> Close X1/PTC if there is no external protective device connected.. Refer to Motor sensor connection (page 35) for detailed information..
PHASELOSS ERROR 16	One phase of the power supply does not work.	<ul style="list-style-type: none"> The power supply under full load If phase failure occurs at the input. The circuit breakers And visually inspect the points at the input terminals.
UNDERVOLTAGE	The voltage is too low.	<ul style="list-style-type: none"> Is the supply voltage too low? Is there phase failure at the input? Is there asymmetry between the phases?
COMM LOST	The communication between the power unit and the control board does not work correctly.	Is the connection between the control board and the power unit correct?
LACK OF WATER ERROR 21	The low water sensor connection, terminals X3/11-12, is opened. The sensor is only active when the pump runs.	<ul style="list-style-type: none"> The incoming pressure or minimum water level values are set too low, then change the settings. The error only happens for a short time, then adjust parameter P610 DELAY TIME. <p>If a sensor is not used, then the terminals X3/11-12 must be bridged.¹</p>
MIN. THRESHOLD ERROR 22	The defined value of parameter P605 MIN.THRESH. was not reached during the preselected P610 DELAY TIME .	<ul style="list-style-type: none"> The booster unit and adjust the parameter P610 DELAY TIME. Set the parameter P615 ERROR RESET set to ON, to enable five restarts in the empty system.
FAILURE SENSOR 1, ACT. VAL. SENSOR 1 ERROR 23	Sensor signal on terminals X3/2 is less than 4 mA which an active sensor must deliver.	<ul style="list-style-type: none"> The Actual value signal from the pressure transducer is faulty. The connection is faulty. The sensor or cables are faulty. Check the configuration of the sensors in P400 SUBMENU SENSOR.

¹ The unit is reset when the terminals X3/11-12 are closed.

Error	Cause	Check the following:
FAILURE SENSOR 2, ACT. VAL. SENSOR 2 ERROR 24	Sensor signal on terminals X3/4 is less than 4 mA which an active sensor must deliver.	<ul style="list-style-type: none"> The Actual value signal from the pressure transducer is faulty. The connection is faulty. The sensor or cables are faulty. Check the configuration of the sensors in P400 SUBMENU SENSOR.
SETPOINT 1 I < 4mA, SETPOINT 1 I < 4 mA ERROR 25	Current signal input of required values is active, but no signal between 4-20 mA is connected.	<ul style="list-style-type: none"> External analog signal on terminals X3/17-18 Configuration of the required values in P800 SUBMENU REQUIRED VALUES.
SETPOINT 2 I < 4 mA, SETPOINT 2 I < 4 mA ERROR 26	Current signal input of required values is active, but no signal between 4-20 mA is connected.	<ul style="list-style-type: none"> External analog signal on terminals X3/22-23 Configuration of the required values in P800 SUBMENU REQUIRED VALUES.

10.3 Internal error, on display or red LED ON

To reset errors, the power supply has to be cut for more than 60 seconds. If the error message is still shown on the display, then contact your local distributor and provide a detailed description of the error.

Error	Cause	Remedy
ERROR 1	EEPROM-ERROR, data block malfunction	Reset the unit. If the error message repeats then change control board.
ERROR 4	Button error, for example a jammed key	Check and make sure that the push buttons are OK. If the push buttons are faulty, then change the display-board.
ERROR 5	EPROM-ERROR, checksum error	Reset the unit. If the error message repeats then change control board.
ERROR 6	Program error: Watchdog error	Reset the unit. If the error message repeats then change control board.
ERROR 7	Program error: Processor pulse error	Reset the unit. If the error message repeats then change control board.
CODE ERROR	Code error: invalid processor command	Check and make sure that the: <ul style="list-style-type: none"> Installation of the cables, connection of the screen and potential equalization is correct. Ground is correctly installed. Signal is strong enough, if not, install additional ferrite inductances to boost the signal.

11 Technical Reference

11.1 Example: P105 ACTUATOR mode

Graph

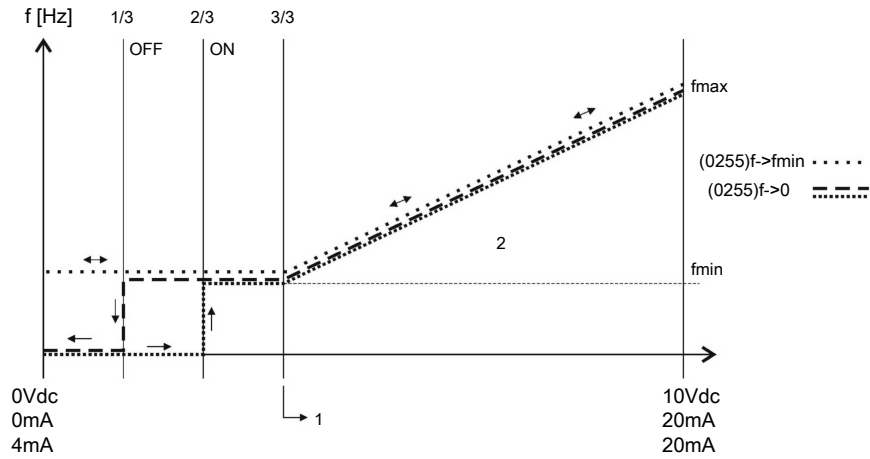

Position numbers

1. Signal range * $(f_{min} / f_{max}) + \text{zeropoint}$
2. Range of control

11.2 Example: P200 Ramp Settings

Graph

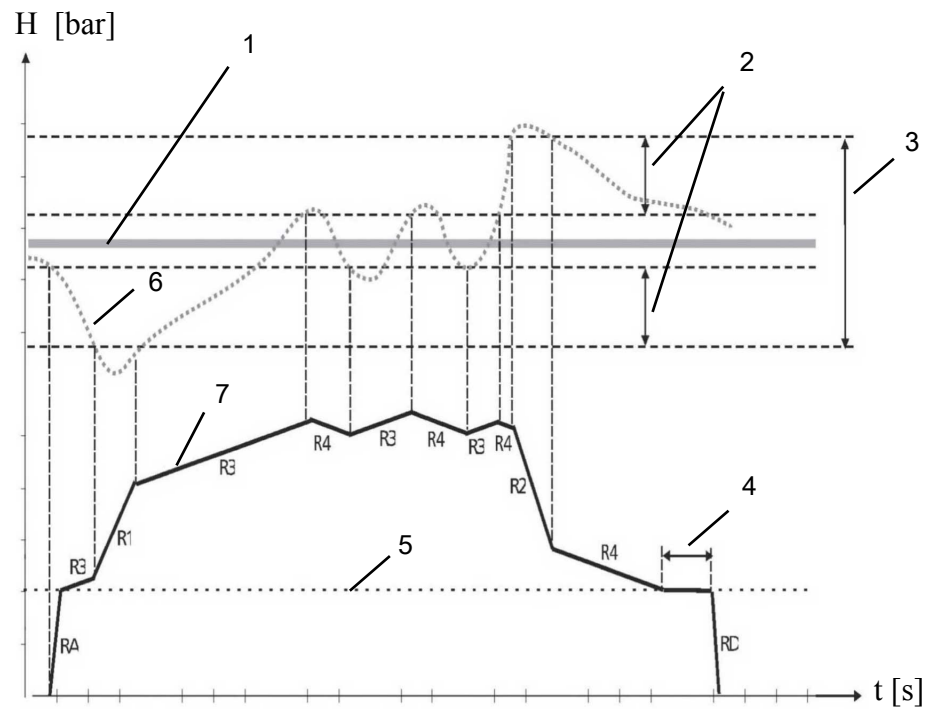

Position numbers

1. P02 REQUIRED VAL.
2. P315 HYSTERESIS in % of P310 WINDOW.

3. P310 **WINDOW** in % of P02 **REQUIRED VAL.**
4. P260 **FMIN TIME** **FMIN TIME**
5. P250 **MIN.FREQ.**
6. **Actual value**
7. **Output frequency**

Description

RA: **RAMP FMIN A**

RD: **RAMP FMIN D**

R1: **RAMP 1** - speed ramp fast increase

R2: **RAMP 2** - speed ramp fast decrease

R3: **RAMP 3** - speed ramp slow increase

R4: **RAMP 4** - speed ramp slow decrease

Adjust ramp settings

To adjust the ramps presented above, see separate sections in [M200 CONF.INVERTER](#) (page 57).

11.3 Example: P330 LIFT AMOUNT

Follow these instructions to set the lift amount.

1. Enter the set pressure.

See [P02 REQUIRED VAL.](#) (page 46).

2. Close all valves in the system and start the HYDROVAR® to read the frequency displayed.

Another possibility to find out the frequency for the set pressure at zero demand is to use the P305 **JOG** mode. For more information, see [P305 JOG](#) (page 69).

3. Set the frequency value (set pressure at zero demand) in P325 **FRQ. LIFT.**

For more information, see [P325 FRQ.LIFT](#) (page 71).

4. Set the P330 **LIFT AMOUNT** (increase in % of the set pressure) to compensate the friction losses in the system.

Example: set pressure = 4 bar, lift amount: a) 0% (= 4 bar, no lift), b) 100% (= 8 bar), c) 200% (=12 bar)

For more information see [P330 LIFT AMOUNT](#) (page 71). This is set as % of the set pressure.

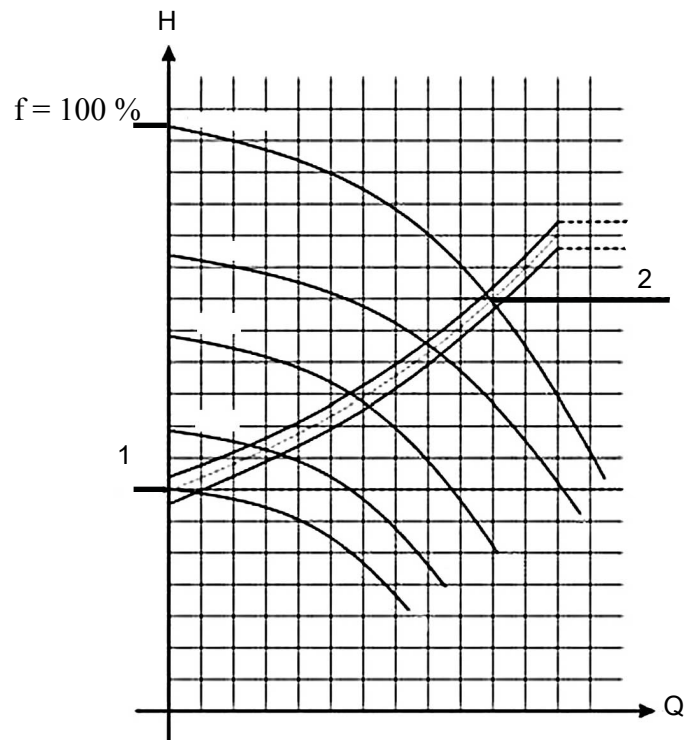
Graph**Position numbers**

1. The pressure at zero demand (all valves closed).
2. The pressure plus lift amount to compensate the friction loss.

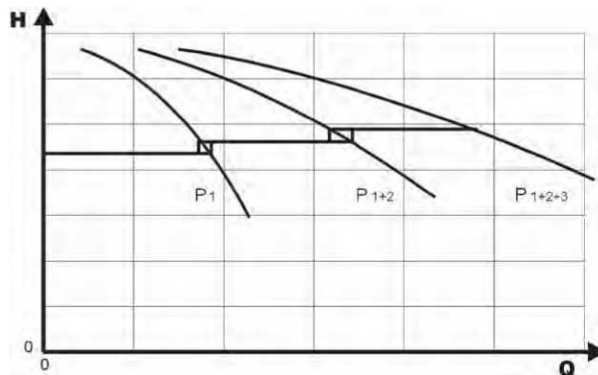
11.4 Example: P500 SUBMENU SEQUENCE CNTR.**Graph****Calculation process for the sequence centre value**

1. Lead pump reaches its P515 **ENABLE FRQ.**
2. Actual value falls to the cut in-value of the 1st assist pump. The 1st assist pump switches on automatically. (Cut in-value = P02 **REQUIRED VAL** - P510 **ACT.VAL.DEC**)
3. A new required value, P03 **EFF.REQ.VAL** is calculated after the start up. P03 **EFF.REQ.VAL** = P02 **REQUIRED VAL** - P510 **ACT.VAL.DEC** + P505 **ACT.VAL.INC**

Calculations of the new required value for multi pump applications

k.... number of active pumps (k > 1)

$$p = p_{\text{set}} + (k-1) * (P505 \text{ ACT.VAL.INC} - P510 \text{ ACT.VAL.DEC})$$

- P505 **ACT.VAL.INC** = P510 **ACT.VAL.DEC** → Pressure constant, independent of how many pumps are in operation.
- P505 **ACT.VAL.INC** > P510 **ACT.VAL.DEC** → Pressure rises when assist pump switches on.
- P505 **ACT.VAL.INC** < P510 **ACT.VAL.DEC** → Pressure falls when assist pump switches on.

To find out the right setting for Synchronous control

1. Start the first pump in P62 **JOG** mode.
2. Increase the frequency until the required value is met. Check the frequency at zero consumption, f_0 .
3. Set the synchronous limit, $f_0 + 2..3$ Hz.
4. Set the synchronous window between 1 or 2 Hz depending on the pump curve and the set point.

11.5 Example: P900 SUBMENU OFFSET

General settings

Constant pressure system with the required value of 5 bar.

Additionally a flow sensor is connected to the offset input.

Parameter P907 **OFFS.RANGE** = 160 (maximum range of flow sensor = 16 m³/h).

System requirement 1

- Constant pressure: 5 bar
- Flow rate: 5 - 12 m³/h

Below 5 m³/h decrease the pressure to maximum 2,5 bar at a flow rate of 2 m³/h.

Settings:

- Parameter P910 **LEVEL 1** = 50 = 5 m³/h. First limit where the offset function is active.
- Parameter P912 **OFFSET X1** = 20 = 2 m³/h. Fixed point according to the requirements.
- Parameter P913 **OFFSET Y1** = 2,5 = 2,5 bar. Maximum allowed pressure at this flow rate.

System requirement 2

- Constant pressure: 5 bar
- Flow rate: 5 - 12 m³/h

Above 12 m³/h increase the pressure with the limitation to have maximum 6,0 bar at maximum flow rate of 16 m³/h.

Settings:

- Parameter P915 **LEVEL 2** = 120 = 120 m³/h. Second limit where the offset function is active.
- Parameter P917 **OFFSET X2** = 160 = 16 m³/h. Fixed point according to the requirements.
- Parameter P918 **OFFSET Y2** = 6 = 6 bar. Required pressure at this flow rate.

Graph

See graph below for more details.

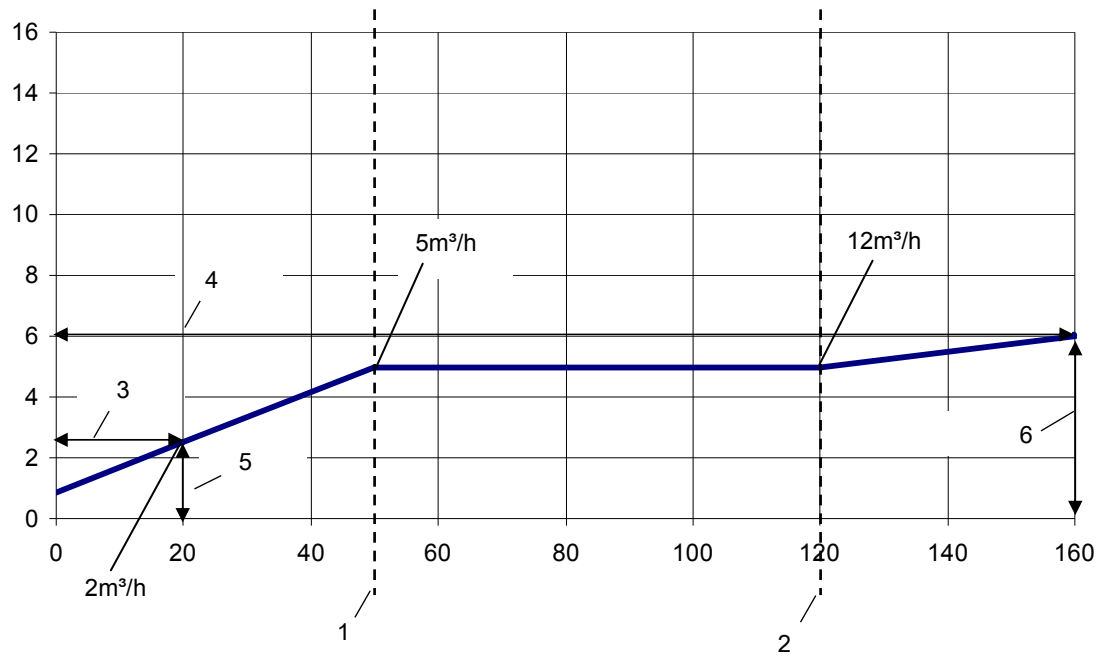

Position numbers

1. LEVEL 1
2. LEVEL 2
3. OFFSET X1
4. OFFSET X2
5. OFFSET Y1
6. OFFSET Y2

11.6 Programming flow charts

Submenu 0 - 40

Submenu 0-40	ID	Name	Example menu
<pre> graph TD subgraph Level_0 [Level 0] 0 --> HOME --> 2 --> 3 --> 4 --> 5 end subgraph Level_20 [Level 20] 20 --> 21 --> 22 --> 23 --> 24 --> 25 26 --> 27 --> 28 --> 29 --> 30 35 end subgraph Level_40 [Level 40] 40 --> 41 --> 42 --> 43 --> 44 --> 45 46 --> 47 end 0 --> 20 20 --> 40 5 --> 0 25 --> 20 30 --> 20 35 --> 20 45 --> 40 47 --> 40 </pre>	0	MAIN	
	HOME		Actual value
	2	REQUIRED VAL.	3,5 bar
	3	EFF.REQ.VAL.	3,5 bar
	4	START VALUE	Off
	5	LANGUAGE	English
	6	DATE	xx.xx.20xx
	7	TIME	xx:xx
	8	AUTO-START	Off
	9	OPERAT.TIME	xxxx:xx
	20	STATUS	
	21	STATUS UNITS	00000000
	22	SELECT DEVICE	* 1 *
	23	STATUS DEVICE	Running
	24	ENABLE DEVICE	Enabled
	25	MOTOR HOURS	xxxx:xx
	26	1ST ERROR	No Error
	27	2ND ERROR	No Error
	28	3RD ERROR	No Error
	29	4TH ERROR	No Error
	30	5TH ERROR	No Error
	35	KWH COUNTER	kWh
	40	DIAGNOSTICS	
	41	PROD.DATE	xx.xx.20xx
	42	SEL.INVERTER	* 11
	43	TEMP.INVERTER	x: <xx % <xx C
	44	CURR.INVERTER	x: xx %
	45	VOLT.INVERTER	x: xxx V
	46	OUTPUT FREQ.	x: xx.x Hz
	47	VER.INVERTER	x: xx

Submenu 60 - 300

Submenu 60-300	ID	Name	Example menu
	60	SETTINGS	
	61	PASSWORD	0000
	62	JOG	xx.x Hz 3,5 bar
	100	BASIC SETTINGS	
	105	MODE	Controller
	106	PUMP ADDR.	1
	110	SET PASSW.	0066
	115	LOCK FUNCT.	OFF
	120	DISP.CONTR.	75 %
	125	DISP.BRIGHT.	100 %
	200	CONF.INVERTER	
	202	SOFTWARE	HV V01.4
	205	MAX.UNITS	6
	210	INVERTER	All
	215	RAMP 1	4 sec
	220	RAMP 2	4 sec
	225	RAMP 3	70 sec
	230	RAMP 4	70 sec
	235	RAMP FMIN A	2,0 sec
	240	RAMP FMIN D	2,0 sec
	245	MAX.FREQ.	50 Hz
	250	MIN.FREQ.	20 Hz
	255	CONF.FMIN	f->0
	260	FMIN TIME	0 sec
	261	SKIP FRQ.CTR.	20.0 Hz
	262	SKIP FRQ.RNG.	0.0 Hz
	265	MOTOR NOM.POWER	1.5 kW
	266	MOTOR NOM.VOLT.	230 V
	267	MOTOR NOM.FRQ.	50.0 Hz
	268	MOTOR NOM.CURR.	7.5 A
	269	MOTOR NOM.SPEED	3000 rpm
	270	MOTOR POLES	2
	275	AMPI	Full
	280	SWITCHING CONTROL	HVC
	281	BOOST	5 %
	282	KNEE FREQ.	50.0 Hz
283	SEL.SW.FREQ.	10 kHz	
290	STC MOTOR PROT.	STC Trip	
291	STC MOTOR THERMAL	77 %	
295	CURR.LIM.FUNCT.	Off	
296	CURR.LIMIT SET	110 %	
	300	REGULATION	
	305	JOG	0.0 Hz

Submenu 60-300	ID	Name	Example menu
	310	WINDOW	10 %
	315	HYSTERESIS	80 %
	320	REG.MODE	Normal
	325	FRQ.LIFT	30,0 Hz
	330	LIFT AMOUNT	0,0 %

Submenu 400 - 500

Submenu 400-500	ID	Name	Example menu
	400	SENSOR	
	405	DIMENSION UNIT	bar
	410	CONF.SENSOR	Sensor 1
	415	SENSOR TYPE	Analog I 4 - 20 mA
	420	SENSOR RANGE	10.00 bar
	425	SENSOR CURVE	linear
	430	SENS.1 CAL.0	0% = x.xx bar
	435	SENS.1 CAL.X	0% = xx.xx bar
	440	SENS.2 CAL.0	0% = xx.xx bar
	445	SENS.2 CAL.X	0% = xx.xx bar
	500	SEQUENCE CONTR.	
	505	ACT.VAL.INC.	0,35 bar
	510	ACT.VAL.DEC.	0,15 bar
	515	ENABLE FRQ.	48 Hz
	520	ENABLE DLY.	5 sec
	525	SWITCH DLY.	2 sec
	530	DISABLE FRQ.	30,0 Hz
	535	DISABLE DLY.	5 sec
	540	DROP FRQ.	42,0 Hz
	545	OVERVALUE	Disabled
550	OVERVAL.DLY.	0.0 sec	
555	SWITCH INTV.	24 hours	
560	SYNCHR.LIM.	0,0 Hz	
565	SYNCHR.WND.	2.0 Hz	

Submenu 600 - 1200

Submenu 600-1200	ID	Name	Example menu
<p>The diagram shows a hierarchical menu structure. At the top is ID 600. Below it are two rows: 605, 610, 615 and 700, 705, 710, 715, 720. Below that are two rows: 800, 805, 810, 815, 820, 825 and 830, 835. Below that are two rows: 900, 905, 907, 910, 912, 913 and 915, 917, 918. Below that are two rows: 1000, 1005, 1010, 1015, 1020, 1025 and 1030. Below that are two rows: 1100, 1110, 1120 and 1200, 1205, 1210, 1215, 1220. At the bottom is ID 1200. Arrows indicate the flow between these submenus.</p>	600	ERROR	
	605	MIN.THRESH.	Disabled
	610	DELAY-TIME	2 sec
	615	ERROR RESET	On
	700	OUTPUTS	
	705	ANALOG OUT.1	Output frequency
	710	ANALOG OUT.2	Actual value
	715	CONF.REL.1	Running
	720	CONF.REL.2	Errors
	800	REQUIRED VALUES	
	805	C.REQ.VAL.1	Digital
	810	C.REQ.VAL.2	Off
	815	SW.REQ.VAL.	Setpoint 1
	820	REQ.VAL.1	3,5 bar
	825	REQ.VAL.2	3,5 bar
	830	ACTUAT.FRQ1	0.0 Hz
	835	ACTUAT.FRQ2	0.0 Hz
	900	OFFSET	
	905	OFFS.INPUT	Off
	907	OFFSET RANGE	100
	910	LEVEL 1	0
912	OFFSET X1	0	
913	OFFSET Y1	0,00 bar	
915	LEVEL 2	100	
917	OFFSET X2	100	
918	OFFSET Y2	0,00 bar	
1000	TEST RUN		
1005	TEST RUN		
1010	TEST RUN FRQ.	30.0 Hz	
1015	TEST R.BOOST	10%	
1020	TEST R.TIME	5 sec	
1025	SEL.DEVICE	*1*	
1030	TEST RUN MAN.	Press > for 3 sec	
1100	SETUP		
1110	FACTORY SET	Europe	
1120	PASSWORD 2	0000	
1200	RS-485 INTERFACE		
1203	PROTOCOL	Modbus RTU	
1205	ADDRESS	1	
1210	BAUD RATE	9600	
1215	FORMAT	RTU N81	
1220	PUMP ADDR.	1	
1221	BACNET DEV. ID	84001	

Submenu 1300

Submenu 1300	ID	Name	Example menu
	1300	START-UP	
	1301	LANGUAGE	English
	1302	MOTOR NOM.POWER	
	1303	MOTOR NOM.VOLT.	
	1304	PRE-SET MOTOR ?	Yes
	1305	MOTOR NOM.CURR.	
	1306	MOTOR NOM.SPEED	
	1307	AMPI	Full
	1308	STC MOTOR PROT.	STC Trip
	1309	MODE	Controller
	1310	PUMP ADDR.	1
	1311	CONTROL MODE	Constant
	1312	DIMENSION UNIT	bar
	1313	START-UP COMPLETED?	No
	1314	SENSOR RANGE	
	1315	REQUIRED VAL.	
	1316	START VALUE	100 %
	1317	MIN.THRESH.	Disabled
	1318	DELAY-TIME	2 sec
	1319	DATE	XX.XX.20XX
	1320	TIME	HH.MM
	1321	AUTO-START	On
	1322	START-UP COMPLETED?	No
1323	ADDRESS	1	

Xylem |'zīləm|

- 1) The tissue in plants that brings water upward from the roots
- 2) A leading global water technology company

We're a global team unified in a common purpose: creating innovative solutions to meet our world's water needs. Developing new technologies that will improve the way water is used, conserved, and re-used in the future is central to our work. We move, treat, analyze, and return water to the environment, and we help people use water efficiently, in their homes, buildings, factories and farms. In more than 150 countries, we have strong, long-standing relationships with customers who know us for our powerful combination of leading product brands and applications expertise, backed by a legacy of innovation.

For more information on how Xylem can help you, go to xyleminc.com



Xylem Service Italia S.r.l.
Via Vittorio Lombardi 14
Montecchio Maggiore VI 36075
Italy
Contact your supplier or local sales
and service representative

Visit our Web site for the latest version of this document
and more information

The original instruction is in English. All non-English
instructions are translations of the original instruction.

© 2016 Xylem Inc