

DISTINTA DELLE PARTI COSTITUENTI LE POMPE CENTRIFUGHE AUTOADESCANTI SERIE " J "
SPARE PARTS LIST FOR "J" SERIES SELF-PRIMING PUMPS
LISTE DES PIECES DE RECHANGE POUR POMPES CENTRIFUGES AUTO-AMORCANTES SERIE " J "
ERSATZTEILLISTE FÜR SELBSTANSAUGENDE KREISELPUMPEN SERIE " J "

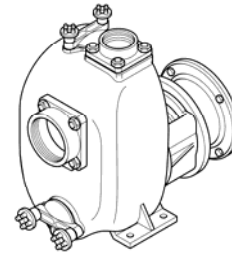
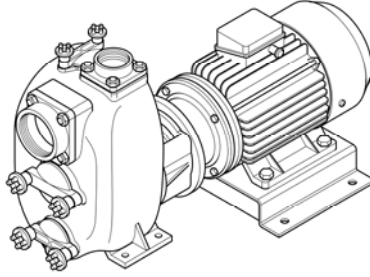
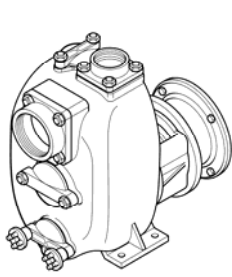

JP 3-140 G10 ETO Code 1004 0879
 JP 3-140 G11 ETO Code 1004 6416
 JP 3-140 F10 ETO Code 1004 6987
 JP 3-140 F20 ETO Code 1004 6988
 JP 3-140 P10 ETO Code 1004 5673
 JP 3-140 Q10 ETO Code 1004 6958
 JP 3-140 K10 ETO Code 1004 6111
 JP 3-140 T10 ETO Code 1004 6990

JE 3-140 G10 ET20 Code 1004 2933
 JE 3-140 G11 ET20 Code 1004 6417
 JE 3-140 F10 ET20 Code 1004 6992
 JE 3-140 F20 ET20 Code 1005 0490
 JE 3-140 P10 ET20 Code 1004 5674
 JE 3-140 Q10 ET20 Code 1004 6960
 JE 3-140 K10 ET20 Code 1004 6273
 JE 3-140 T10 ET20 Code 1004 6994
 JE 3-140 B10 ET20 Code 1004 6993

JP 3-140 B10 ET20 Code 1004 6989

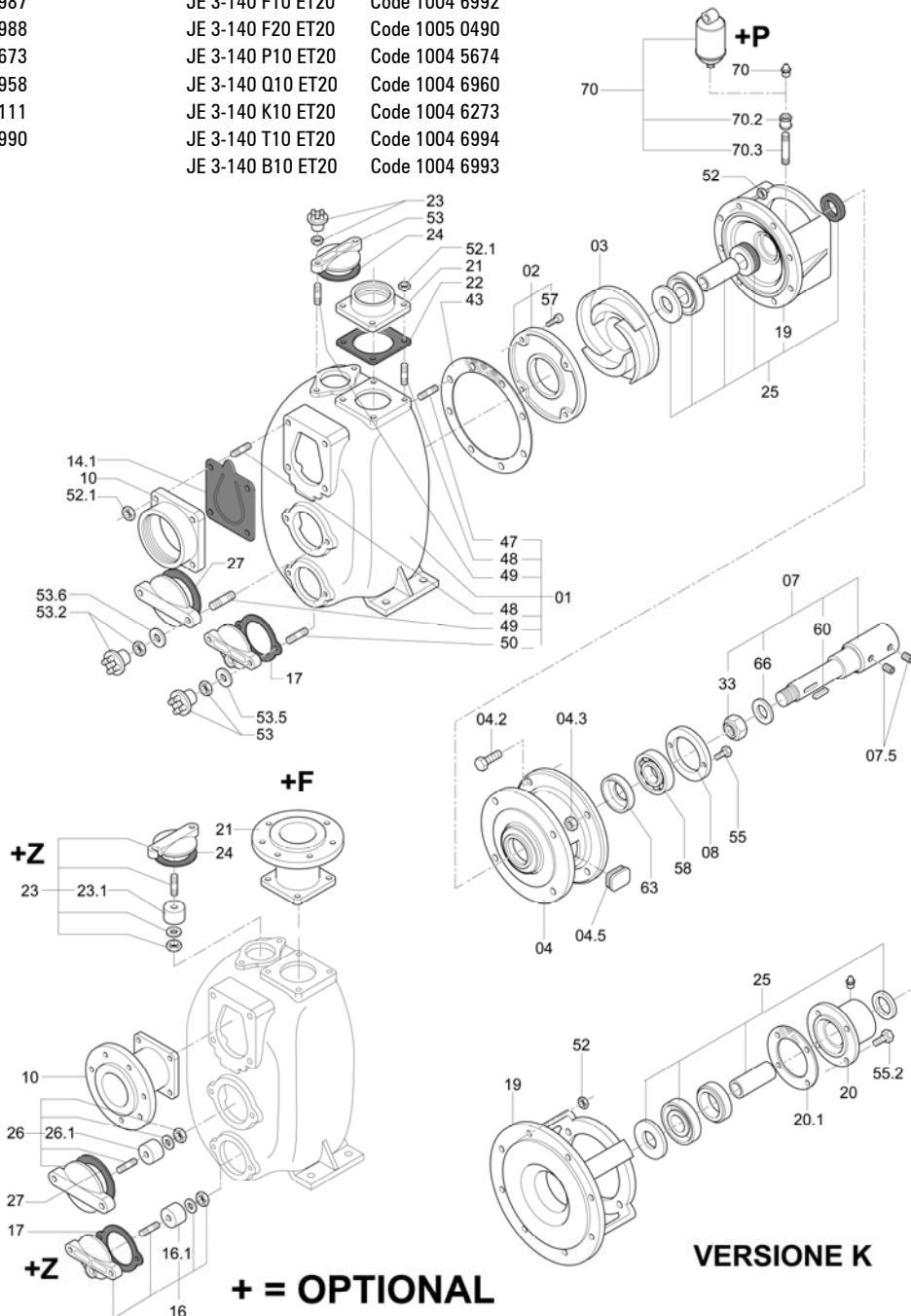

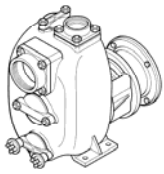

+

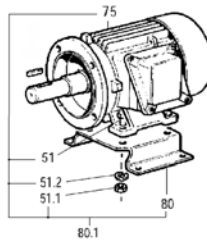

=

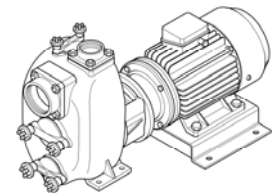

JP

+

MOTORE / MOTOR

=

JE

Rif. N° Pos. Nr.	Quant.	Denominazione	Part name	Den. Comm. Type	Mat. *	Codice Nuovo New Part. No.	JP 3-140	JP 3-140	JP 3-140	JP 3-140	JP 3-140	JP 3-140	JP 3-140	JP 3-140	JP 3-140	JP 3-140
							G10 ETO	G11 ETO	P10 ETO	F10 ETO	F20 ETO	Q.10 ETO	B10 ETO	K10 ETO	K20 ETO	T10 ETO
01	1	Corpo (1)	Casing (1)		G	1001 8199	○	○	○							
					G	1004 7062			○	○	○					
					B	1002 1613							○			
					K	1003 0172								○	○	
					G+QPQ	1004 7063										○
02	1	Piatto d' usura (2)	Wear plate (2)		GN	1000 8457	○									
					G	1000 8413		○	○							
					K	1000 8466				○	○		○	○		
					B	1000 8391						○	○			
					G+QPQ	1004 7064										○
03	1	Girante	Impeller		G	1000 5337	○	○	○							
					K	1000 5413				○	○		○	○		
					B	1000 5227						○	○			
					G+QPQ	1002 8058									○	
04	1	Campana	Coupling flange		G	1004 0680	○	○	○	○	○	○	○	○	○	
04.2	2	Vite	Screw	M 8 x 35 DIN 933	S	1000 1940	○	○	○							
				M 8 x 25 DIN 933	S	1000 1938	○	○	○							
				M 8 x 35 DIN 933	K	1000 2034				○	○	○	○	○		
				M 8 x 25 DIN 933	K	1000 2029				○	○	○	○	○		
04.3	2	Dado	Nut		S	1000 1420	○	○	○							
					K	1000 1435				○	○	○	○	○		
04.5	1	Tappo	Plug			1000 2908	○	○	○	○	○	○	○	○		
07	1	Albero (3)	Shaft (3)		S	1004 0876	○	○	○							
					K	1004 3184				○	○	○	○	○		
07.5	2	Vite	Screw	M 8 x 10 DIN 916	S	1004 8377	○	○	○	○	○	○	○	○		
08	1	Copricuscinetto	Bearing cover		G	1004 0750	○	○	○	○	○	○	○	○		
10	1	Portavalvola	Suction flange	R 3"	G	1000 6422	○	○	○	○						
					OTS	1000 6399					○	○				
					K	1000 6455							○	○		
							+F	+F	+F	+F	+F	+F	+F	+F		
14.1	1	Valvola completa (4)	Check valve ass. (4)		NK	1000 9019	○	○					○			
					TK	1000 9021				○				○		
					VK	1000 9022			○	○		○		○		
16	1	Portina	Cover		S	1000 6473	○	○	○	○						
					G	1000 6486				○						
					OTS	1000 3749							○			
					KL	1000 6502								○	○	
					SZ	1000 8502	+Z	+Z	+Z			○			+Z	
16.1	1	Placca zinco	Zinc anode				+Z	+Z	+Z					+Z		
17 (**)	2	Guarnizione	Gasket													
19	1	Portamotore	Head		G	1000 6342	○		○	○		○				
					G	1000 6343				○						
					G	1001 7540		○								
					K	1000 6371							○	○		
					B	1000 6287							○			
					G+QPQ	1002 3624									○	

Rif. N° Pos. Nr.	Quant.	Denominazione	Part name	Den. Comm. Type	Mat. *	Codice Nuovo Part. No.	JP 3-140 G10 ETO	JP 3-140 G11 ETO	JP 3-140 P10 ETO	JP 3-140 F10 ETO	JP 3-140 F20 ETO	JP 3-140 Q10 ETO	JP 3-140 B10 ETO	JP 3-140 K10 ETO	JP 3-140 K20 ETO	JP 3-140 T10 ETO
20	1	Portatenuta	Seal box		K	1000 6252										
20.1	1	Guarnizione	Gasket		E3	1000 5637										
21	1	Flangia mandata	Discharge flange	R 3"	G	1000 5090	○	○	○	○	○					○
					OTS	1000 5070					○	○				
					K	1000 5113							○	○		
							+F	+F	+F	+F	+F	+F	+F	+F	+F	+F
22 (**)	1	Guarnizione	Gasket													
23	1	Portina	Cover		S	1000 6473	○	○	○	○						○
				G	1000 6486					○						
				OTS	1000 3748							○				
				KL	1000 6502									○	○	
				SZ	1000 8502							○				
							+Z	+Z	+Z							
23.1	1	Placca zinco	Zinc anode				+Z	+Z	+Z							+Z
25	1	Anello di tenuta	Mechanical seal ass.	T 30 YYN		1000 8898	○	○					○			○
				T 30 YYT		1004 6652					○				○	
				T 30 YVY		1000 8899				○	○			○		
26	1	Portina	Cover		G	1000 6474	○	○	○	○	○					○
				K	1000 6503								○	○		
				GZ	1000 8503							○				
							+Z	+Z	+Z							
26.1	1	Placca zinco	Zinc anode				+Z	+Z	+Z							+Z
27 (**)	1	Guarnizione	Gasket													
33	1	Dado girante	Impeller nut	M 18 x 1,5 UNI 7474	H	1000 1464	○	○	○							○
				M 18 x 1,5 UNI 7474	K	1000 1471					○	○	○	○	○	○
34	1	Anello spartiacque	Water deflector	65x25,3x2	H	1000 4139		○	○	○		○				
43 (**)	1	Guarnizione corpo	Casing gasket													
45	4	Vite	Screw	M 8 x 25 DIN 933	S	1000 1938	○	○	○							○
				M 8 x 25 DIN 933	K	1000 2034					○	○	○	○	○	○
45.1	4	Dado	Nut	M 8 DIN 934	S	1000 1420	○	○	○							○
					K	1000 1434					○	○	○	○	○	○
47 (*)	8	Prigioniero	Stud	M 8x20 DIN 938	S		○	○	○							○
				M 8x18 DIN 938	K					○	○	○	○	○	○	
48 (*)	8	Prigioniero	Stud	M 10x20 DIN 938	S		○	○	○							○
				M 10x25 DIN 938	K					○	○	○	○	○	○	
49 (*)	4	Prigioniero	Stud	M 10x30 DIN 938	S		○	○	○							
				M 10x35 DIN 938	K							○				
				M 10x30 DIN 938	K							○	○	○	○	
51	4	Vite	Screw	M 10 x 30 DIN 933	S	1000 1949	○	○	○	○	○	○	○	○	○	○
51.1	4	Dado	Nut	M 10 DIN 934	S	1000 1421	○	○	○	○	○	○	○	○	○	○
51.2	4	Rondella	Washer	M 10 DIN 125 A	S	1000 1691	○	○	○	○	○	○	○	○	○	○
52 (*)	8	Dado	Nut	M 8 DIN 934	S		○	○	○							○
					H						○	○	○	○	○	○
52.1(*)	8	Dado	Nut	M 10 DIN 934	S		○	○	○							○
					H						○	○	○	○	○	○
53 (*)	4	Dado	Nut	M 10 DIN 934	S		○	○	○							○
					K						○	○	○	○	○	
					OTS											
		Maniglietta	Wrench	M 10	OTS		+M	+M	+M			○				+M
53.2(*)	2	Dado	Nut	M 10 DIN 934	S		○	○	○							○
					K						○	○	○	○	○	
					OTS											
		Maniglietta	Wrench	M 10	OTS		+M	+M	+M			○				+M
53.5(*)	2	Rondella	Washer	M 10 DIN 125 A	S		○	○	○							○
					K						○	○			○	○
53.6(*)	2	Rondella	Washer	M 10 DIN 125 A	S		○	○	○							○
					K						○	○			○	○
54 (*)	2	Prigioniero	Stud	M 10x30 DIN 938	S		○	○	○							
				M 10x35 DIN 938	K								○			
				M 10x30 DIN 938	K							○				

VARISCO S.p.A.

35129 Padova – Z.I. Nord Terza Strada, 9

Tel. 049 82 94 111

Fax 049 82 94 373

+39 049 82 94 111
International +39 049 80 76 762



Rif. N° Pos. Nr.	Quant.	Denominazione	Part name	Den. Comm. Type	Mat. *	Codice Nuovo New Part. No.	JP 3-140 G10 ETO	JP 3-140 G11 ETO	JP 3-140 P10 ETO	JP 3-140 F10 ETO	JP 3-140 F20 ETO	JP 3-140 Q10 ETO	JP 3-140 B10 ETO	JP 3-140 K10 ETO	JP 3-140 K20 ETO	JP 3-140 T10 ETO	
							○	○	○	○	○	○	○	○	○	○	○
55	2	Vite	Screw	M 6x16 DIN 933	S	1000 1932	○	○	○	○	○	○	○	○	○	○	
55.2	4	Vite	Screw	M 8x35 DIN 931		1000 2033											
57 (*)	3	Vite	Screw	M 8x16 DIN 912	H		○	○	○							○	
					K				○	○	○	○	○	○	○	○	
58	1	Cuscinetto	Ball bearing	6206-2RS C3		1004 0831	○	○	○	○	○	○	○	○	○	○	
60	1	Linguetta	Key	8 x 7 x 20 DIN 6885A	K	1000 1621	○	○	○	○	○	○	○	○	○	○	
63	1	Ghiera	Sleeve			1004 0751	○	○	○	○	○	○	○	○	○	○	
66	1	Rondella	Washer	M 18 DIN 125 A	H	1000 1712	○	○	○							○	
					K	1000 1711			○	○	○	○	○	○	○	○	
70	1	Ingrassatore	Grease nipple	R 1/4"		1000 1662	○	○	○	○	○	○	○	○	○	○	
						1000 8316	+P	+P	+P	+P	+P	+P	+P	+P	+P	+P	
70.1	1	Manicotto	Union	R 1/4" M/F	S		+P	+P	+P	+P	+P	+P	+P	+P	+P	+P	
70.2	1	Prolunga	Grease tube	1/4"	S		+P	+P	+P	+P	+P	+P	+P	+P	+P	+P	
75	1	Motore V.230/400(3PH)	AC motor V.230/400(3PH)			1004 1934	○	○	○	○	○	○	○	○	○	○	
80	1	Piede motore	Motor base		S	1004 2044	○	○	○	○	○	○	○	○	○	○	
80.1	1	Kit piede motore	Electric motor foot			1004 3172	○	○	○	○	○	○	○	○	○	○	
(*)		Serie viterie	Set of screw			1001 4363	○	○	○							○	
					200	1001 4129							○				
						1001 4126									○		
						1001 4370										○	○
						1001 4153							○	○			
(**)		Serie guarnizioni	Set of gaskets			1001 4364	○	○								○	
						1001 4367			○	○							
						1001 4362					○						
						1001 4379										○	
						1002 7759								○			
						1001 4371										○	
						1001 4368						○					
+F***		Kit flange	Kit flange	DN 80 PN16	G	1004 2810	○	○	○	○	○			○	○	○	
					B	1004 2806						○	○				
					K	1004 2791											
					G	1004 2819	○	○	○	○	○					○	
					B	1004 2823								○	○		
				3" ASA150	K	1004 2827							○	○			
+P***		Kit ingrassatore	Compl. Grease kit			1000 8316	○	○	○	○	○	○	○	○	○		
+Z***		Kit portine	Set of couver		GZ	1001 4128	+Z	+Z	+Z							+Z	
+M***		Kit maniglie	Set of wrench		OTS	1004 2794	+M	+M	+M							+M	
***		Optional															

Note:	Notes:
1) Completo di prigionieri (47, 48, 49, 50).	1) Complete with studs (47, 48, 49, 50).
2) Completo di viti (57).	2) Complete with screws (57).
3) Completo di dado, rondella e linguette (33, 60, 61, 66)	3) Complete with nut, washer and keys (33, 60, 61, 66)
4) Completo di valvola, contrappesi, vite e dado	4) Complete with check valve, weights, screw and nut
* Materiali di costruzione	* Construction materials
E3	Centellen VS 3820
G	Ghisa
H	Acciaio inox AISI 304
K	Acciaio inox AISI 316
KL	Acciaio inox AISI 316
OTS	Ottone
S	Acciaio
T	Teflon
V	Viton
Ordinare il materiale indicando sempre la quantità, la denominazione, il codice del pezzo, il tipo e il numero della pompa.	When ordering spares always indicate: quantity, part name and part number, type and serial number of pump.