

Performance according to ISO 9906 - Annex A

Power datas referred to:

Water [100%]; 277K; 1000kg/m³; 1.57mm²/s

Liquid temperature:

-10°C (14°F) to +110 °C (230°F) for heating pumps

-10°C (14°F) to +85 °C (185°F) for domestic hot water pumps



Pump data

Make	Lowara
Port to port (mm)	220
Electrical connection	Terminals
Specific EEI	<= 0,27
Nominal pressure	PN 6/10
Connection	Flanged / DN 40

Electrical data

Rated voltage	230 V
Frequency	50
Protection class	IP 44
Insulation class	F
Digital input	Contact load: 5V, 10 mA
Digital output	Vmax < 250 VAC / Imax < 2 A
Analog input	0-10 V / 4-20 mA
Leakage current	< 3.5 mA
Communication capabilities	Modbus RTU & BACnet MS/TP
Sound pressure level	<= 43 dB(A)

Materials

Bush Bearing	Carbon, resin impregnated	impeller	PPS
Thrust bearing	Aluminum oxide	Wear ring	Stainless steel
Bearing plate	Stainless steel	Rotor can	Stainless steel
Motor housing	Aluminum	Shaft	Stainless steel
O-rings	EPDM	Control box	Poly carbonate
PUMP HOUSING	Cast iron		

Dimensions mm

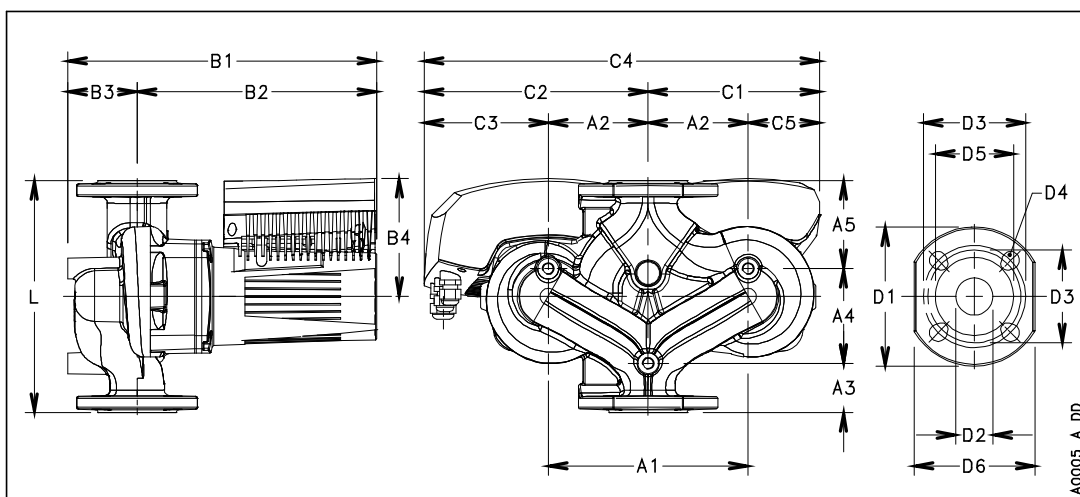

A1	190
A2	95
A3	45
A4	92
A5	83
B1	274
B2	212
B3	62
B4	118
B5	51
C1	157
C2	211
C3	116
C4	368
C5	62
D1	150
D2	40
D3	100/110
D4	4 x 14/19
D5	84
Gross weight	28.7
L	220